



Architectural Millwork Products

Custom Millwork

1330 W 600 N
Logan, UT 84321
(435) 994-5657

SIZING CHART

We can customize most moldings by varying the height and thickness

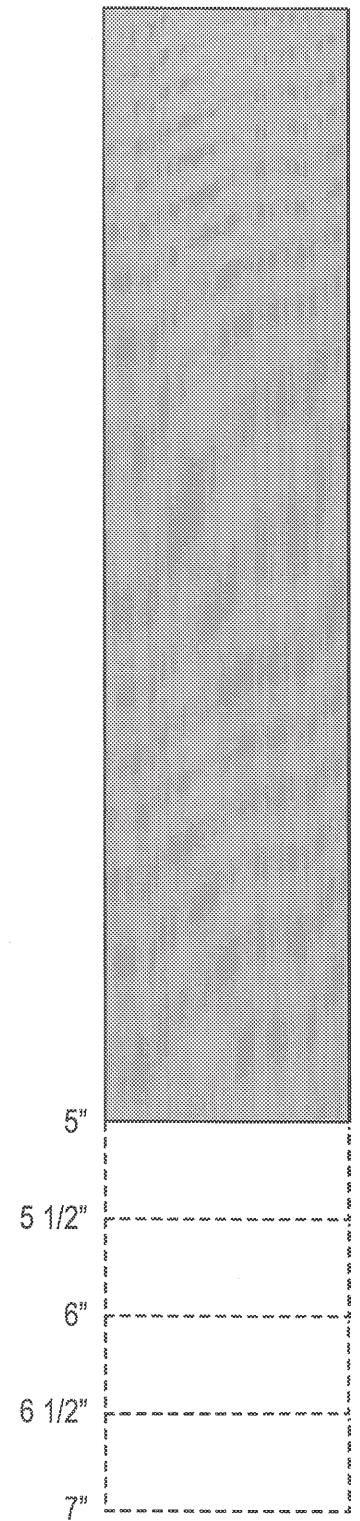
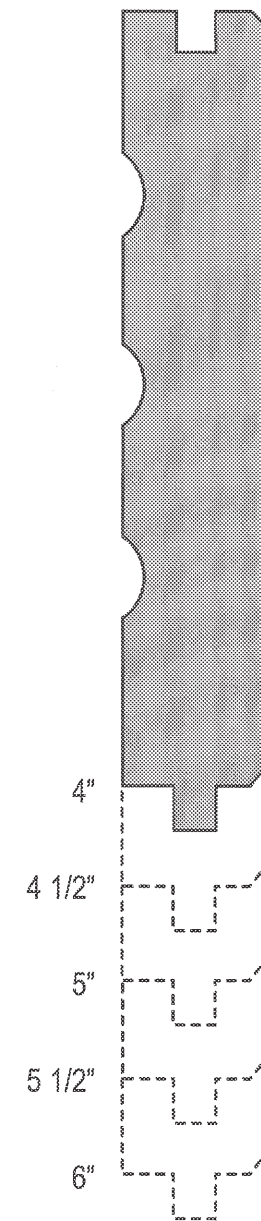
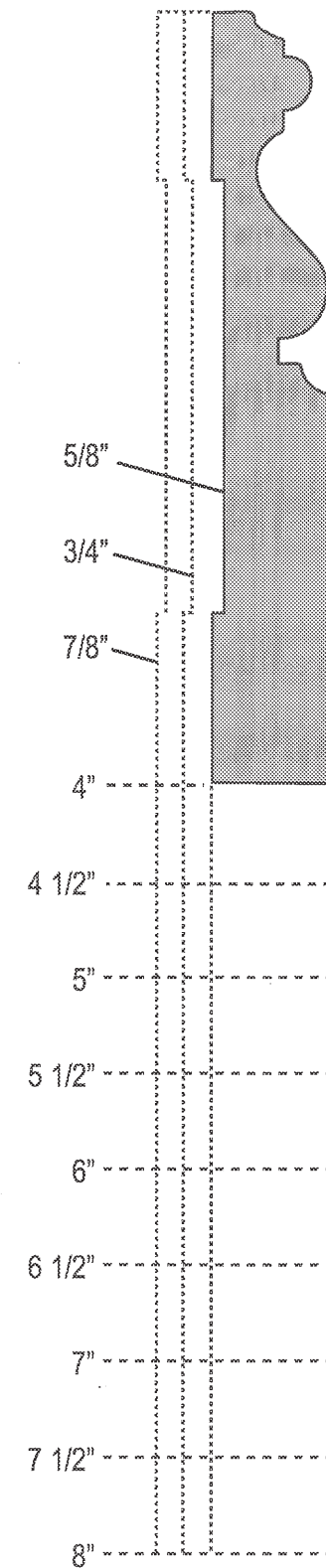

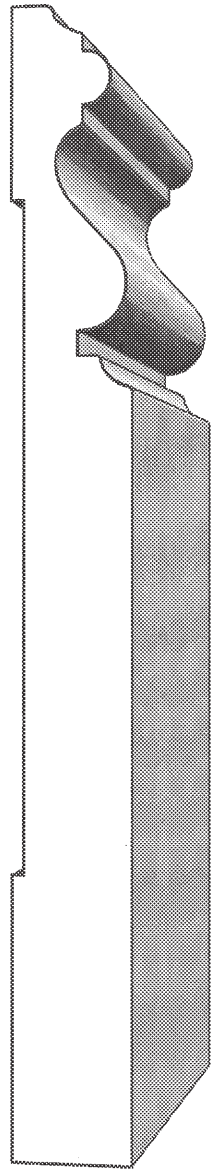

B-01
5/8" X *

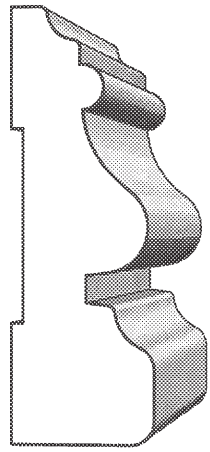

C-01
3/4" X 2 1/4"

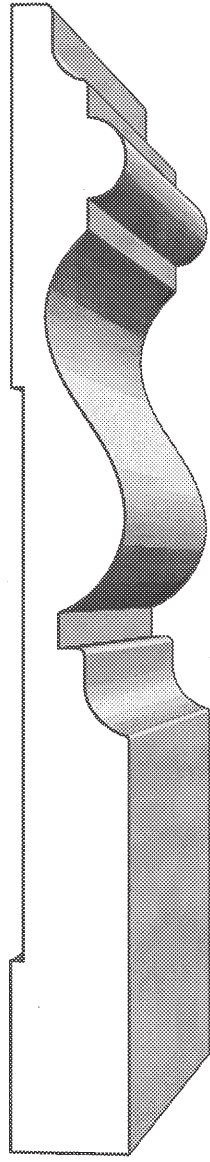

B-02
5/8" X *

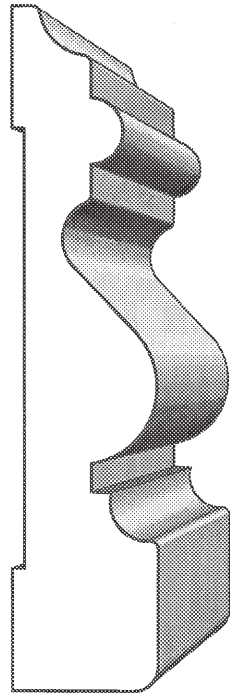

C-02
3/4" X 3 1/2"

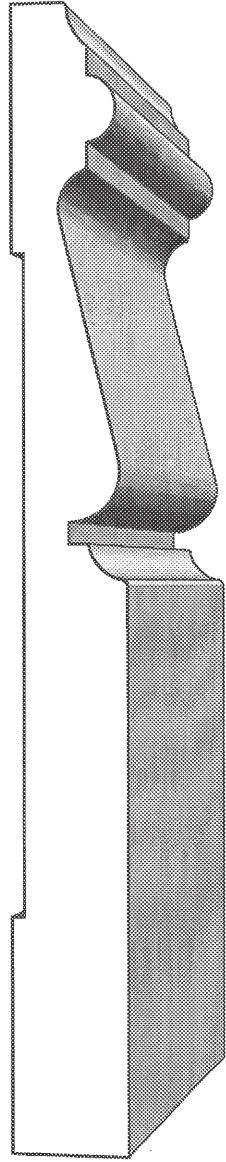

B-03
5/8" X *

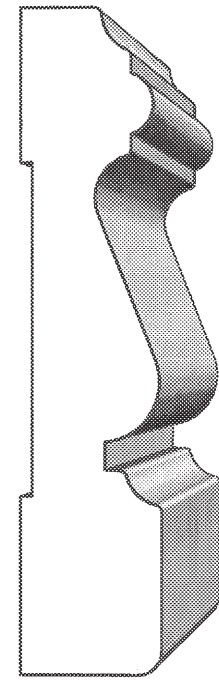

C-03
3/4" X 3 1/2"

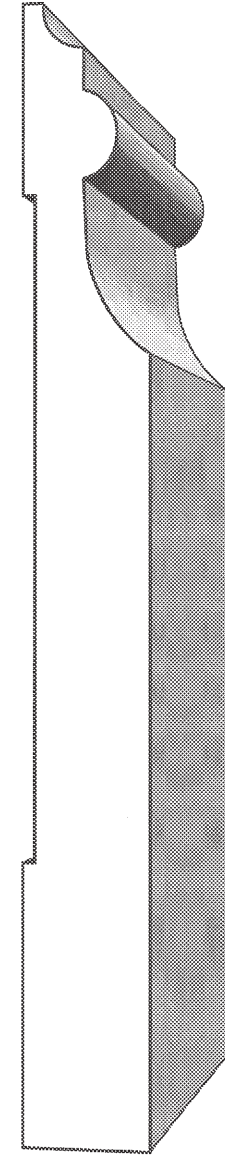

B-22
5/8" X *

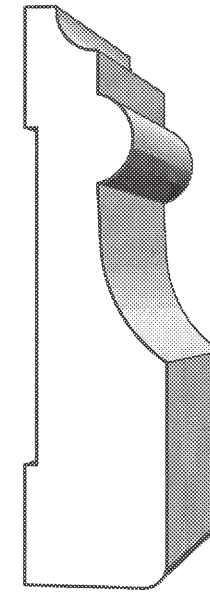

C-22
3/4" X 3"

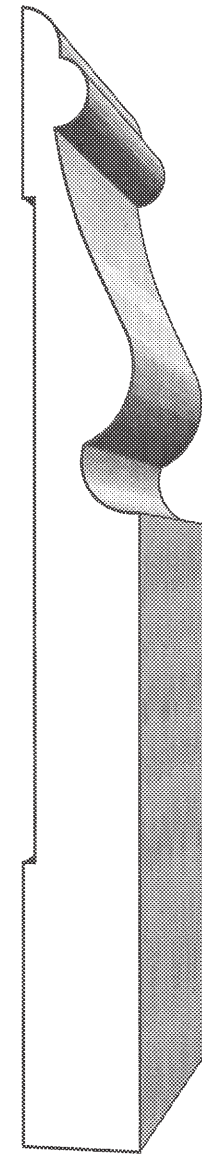

B-23
5/8" X *

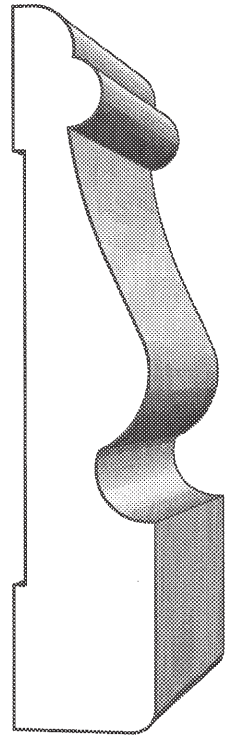

C-23
3/4" X 3 3/4"

* See page 0 for size options.

* See page 0 for size options.



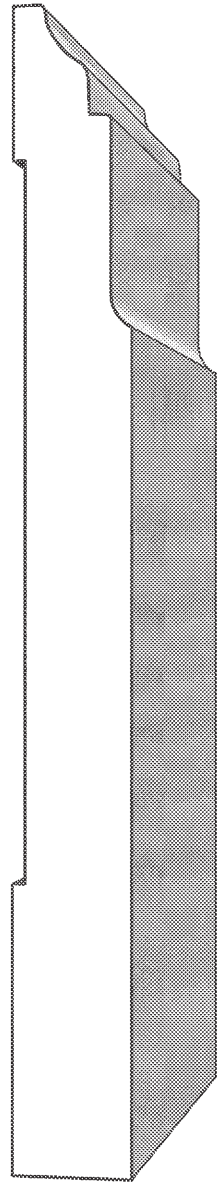

B-04
5/8" X *

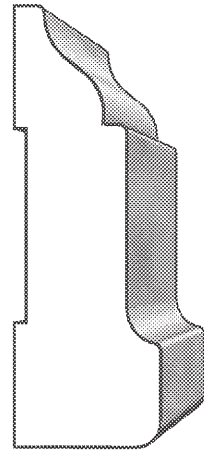

C-04
3/4" X 2 1/4"

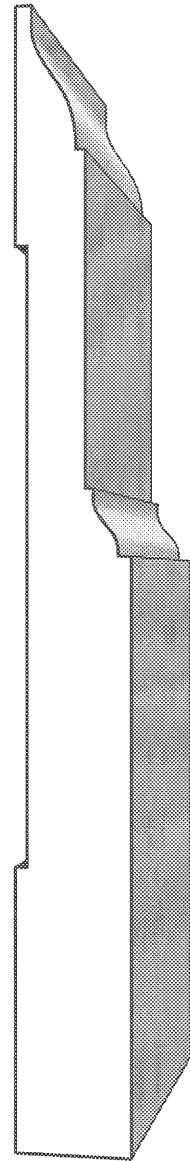

B-27
5/8" X *

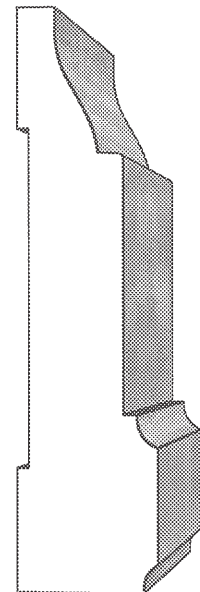

C-27
3/4" X 3"

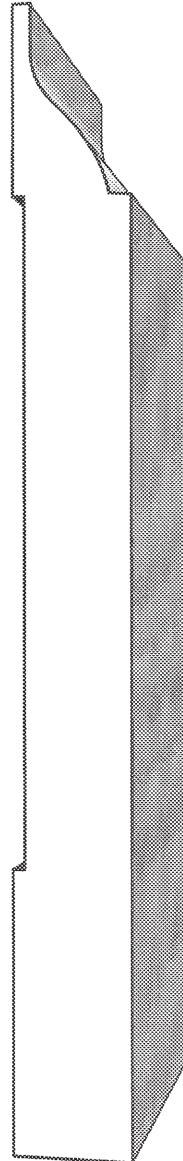

B-26
5/8" X *

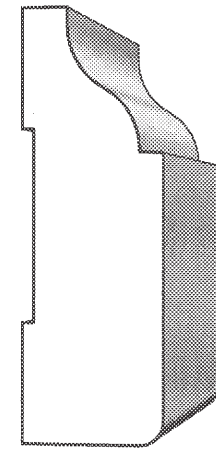

C-26
3/4" X 2 1/4"

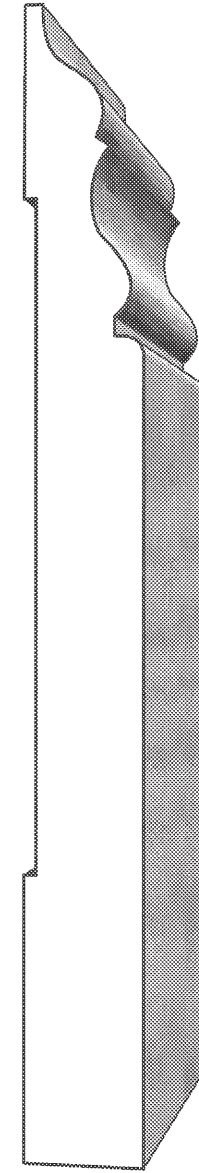

B-05
5/8" X *

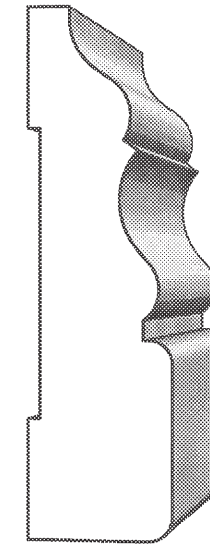

C-05
3/4" X 2 3/4"

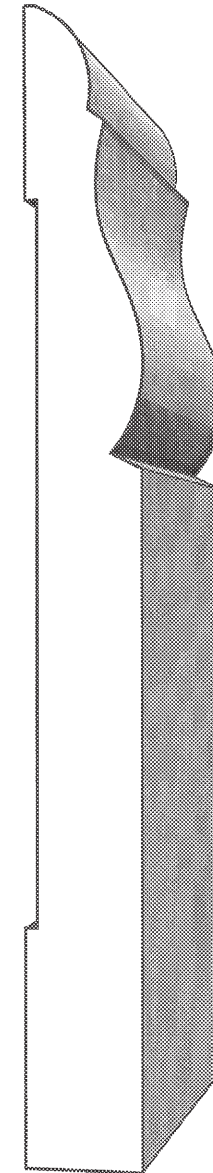

B-10
5/8" X *

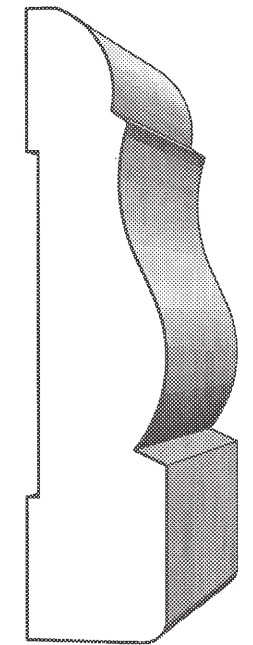

C-10
3/4" X 3 1/2"

* See page 0 for size options.

* See page 0 for size options.



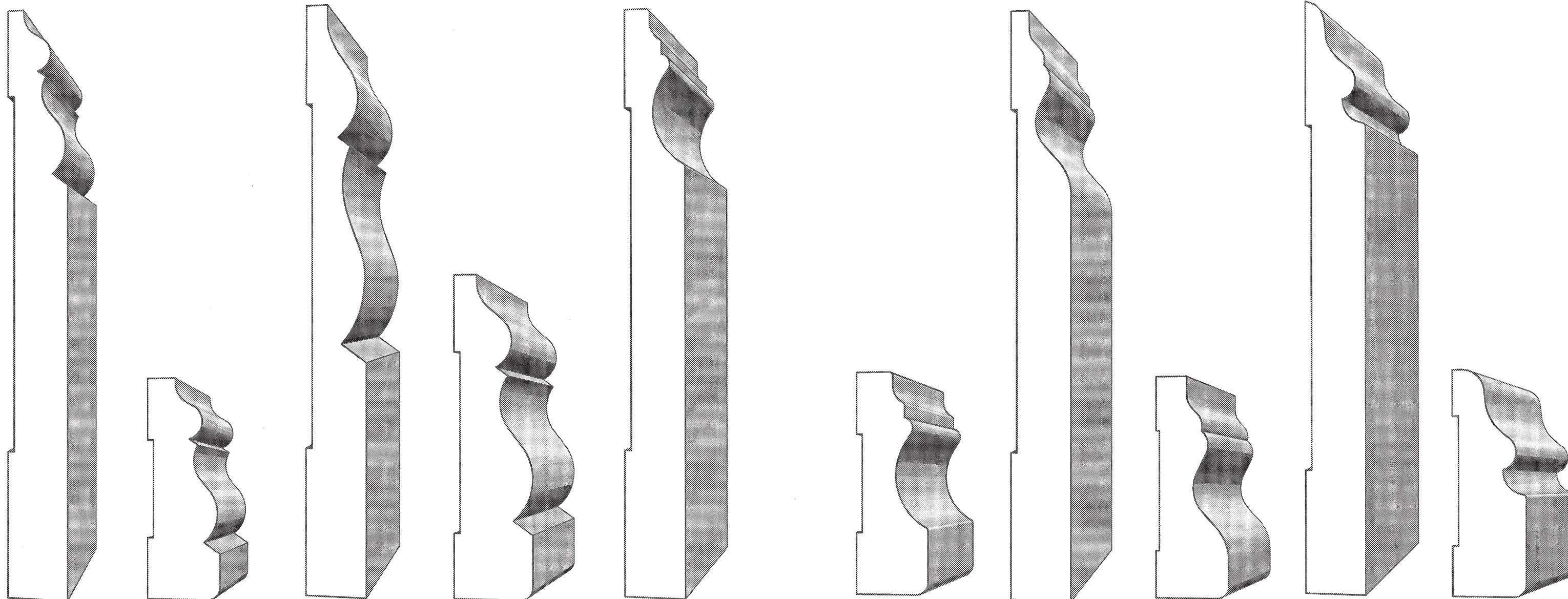

B-28
5/8" X *

C-28
3/4" X 2 1/4"

B-30
5/8" X *

C-30
3/4" X 3 1/4"

B-11
5/8" X *

C-11
3/4" X 2 1/4"

B-29
5/8" X *

C-29
3/4" X 2 1/4"

B-14
5/8" X *

C-14
3/4" X 2 1/4"

* See page 0 for size options.

* See page 0 for size options.



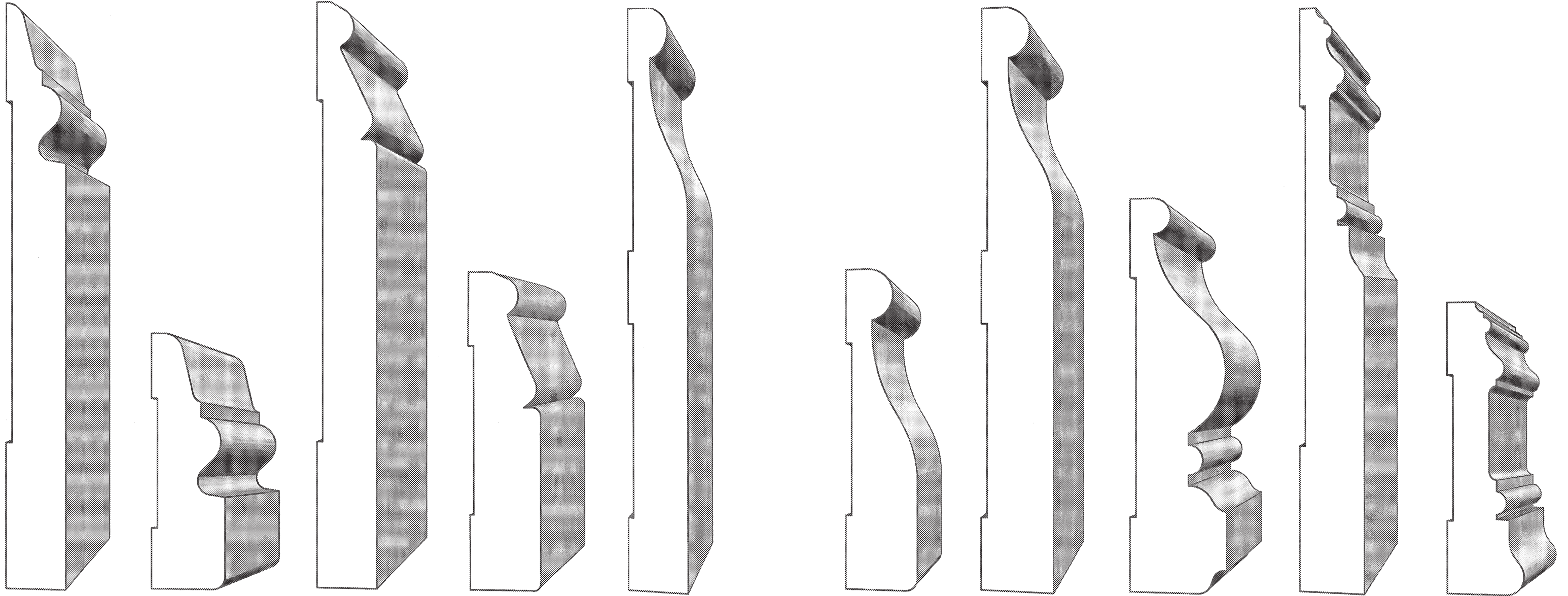

B-17
5/8" X *

C-17
3/4" X 2 5/8"

B-18
5/8" X *

C-18
3/4" X 3 1/4"

B-20
5/8" X *

C-20
3/4" X 3 1/4"

B-21
3/4" X *

C-21
1" X 4"

B-25
5/8" X *

C-25
3/4" X 3"

* See page 0 for size options.

* See page 0 for size options.



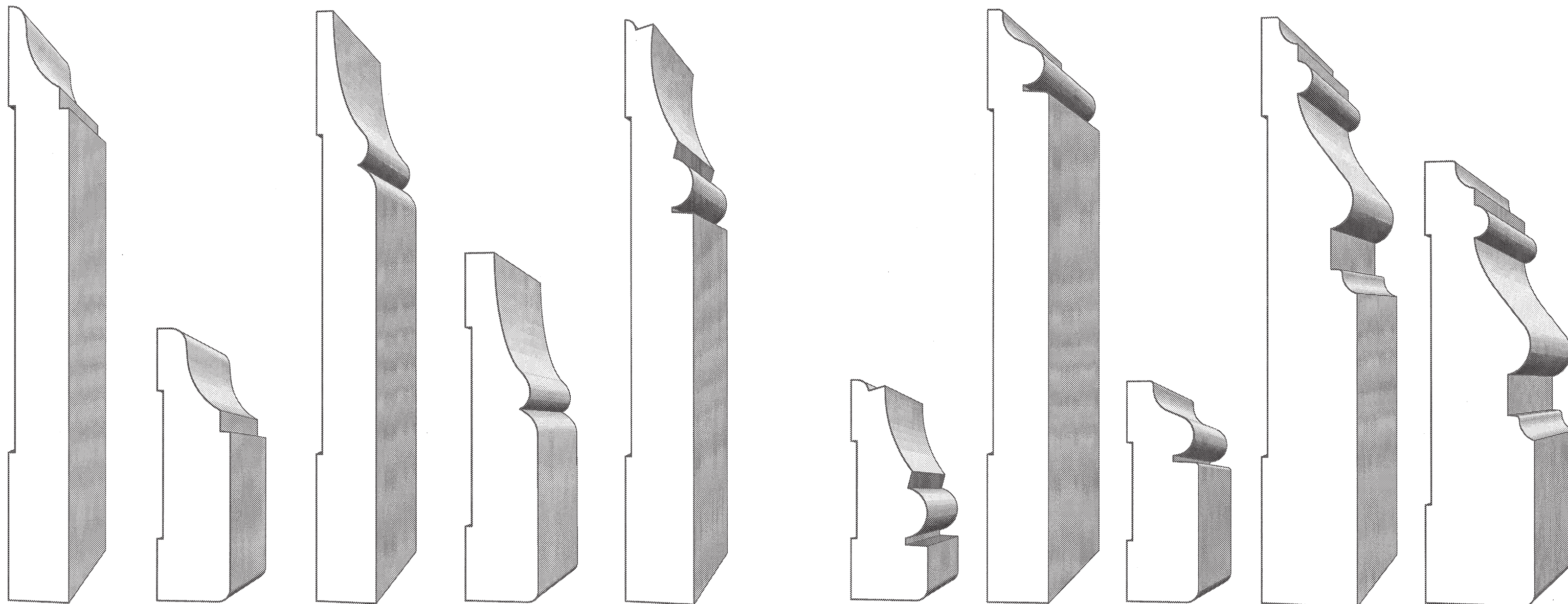

B-07
5/8" X *

C-07
3/4" X 2 3/4"

B-09
5/8" X *

C-09
3/4" X 3 1/2"

B-24
5/8" X *

C-24
3/4" X 2 1/4"

B-19
5/8" X *

C-19
3/4" X 2 1/4"

B-32
1" X *

C-32
1 1/8" X 4 1/2"

* See page 0 for size options.

* See page 0 for size options.



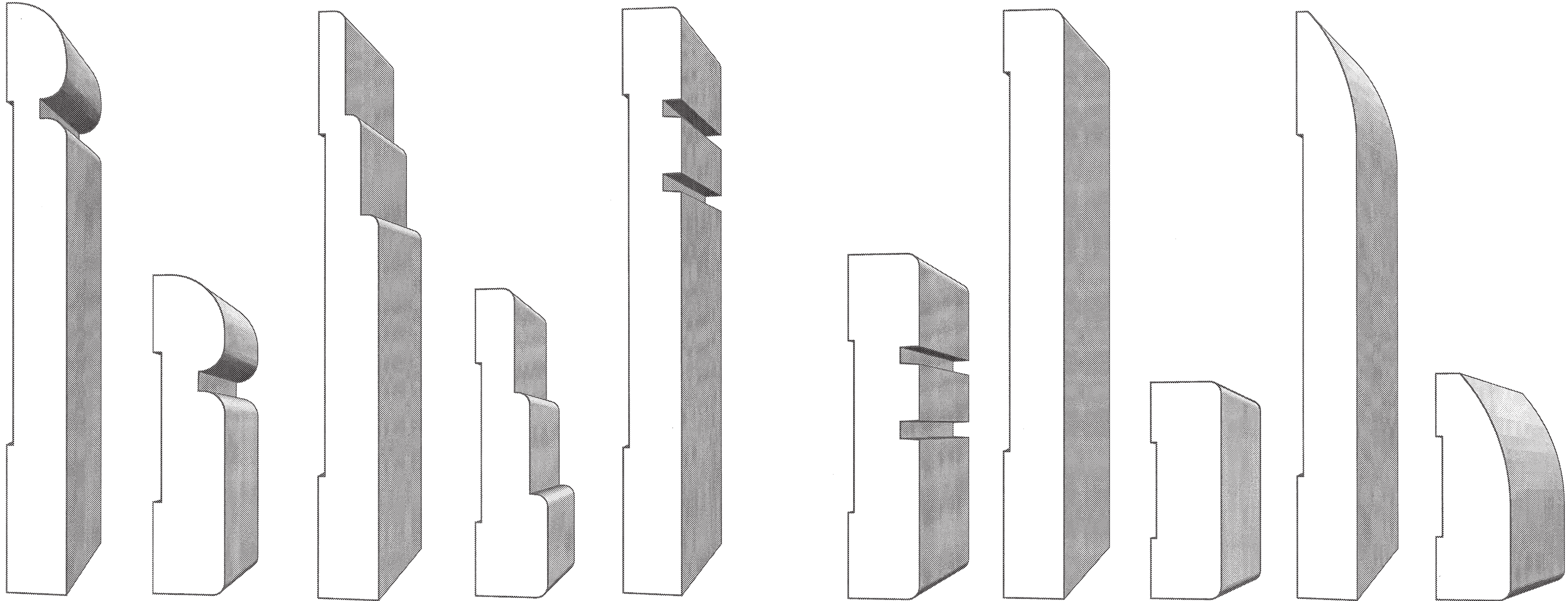

B-08
5/8" X *

C-08
3/4" X 3 1/4"

B-12
5/8" X *

C-12
3/4" X 3 1/8"

B-15
5/8" X *

C-15
3/4" X 3 1/2"

B-16
5/8" X *

C-16
3/4" X 2 1/4"

B-13
5/8" X *

C-13
3/4" X 2 1/4"

* See page 0 for size options.

* See page 0 for size options.



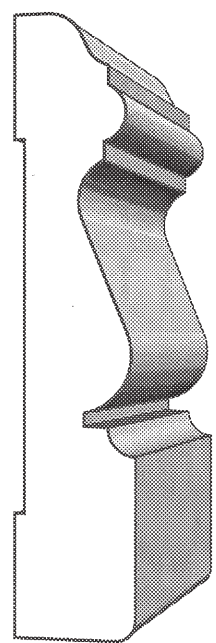

C-47
3/4" X 3 1/4"

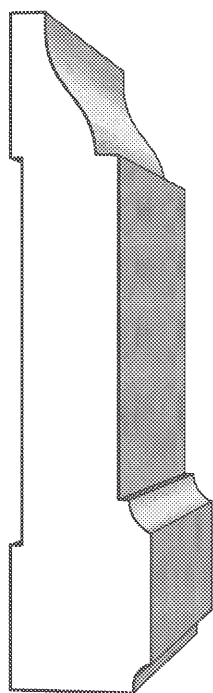

C-31
3/4" X 3 1/2"

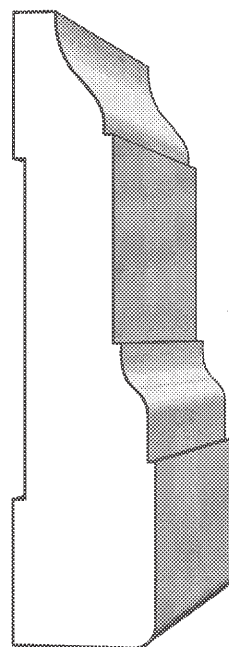

C-33
3/4" X 3 1/4"

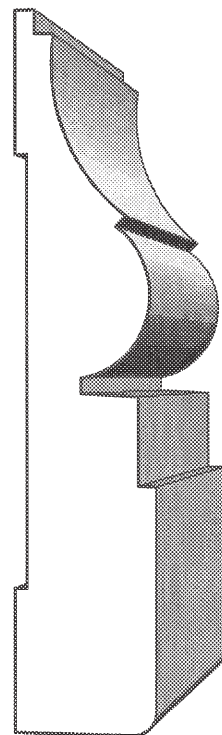

C-34
3/4" X 3 3/4"

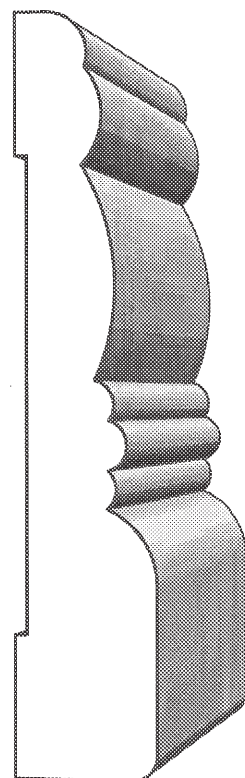

C-35
3/4" X 4"

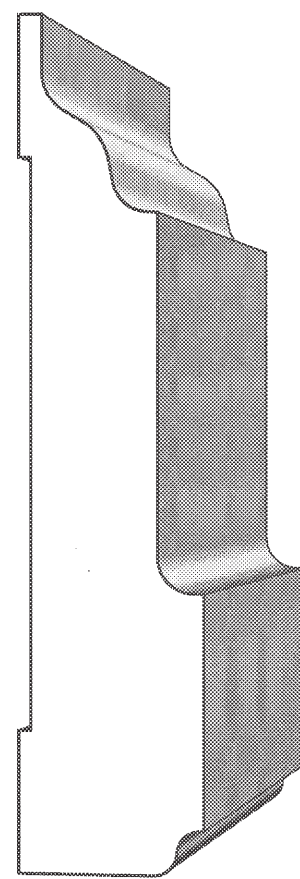

C-36
1" X 4 1/2"

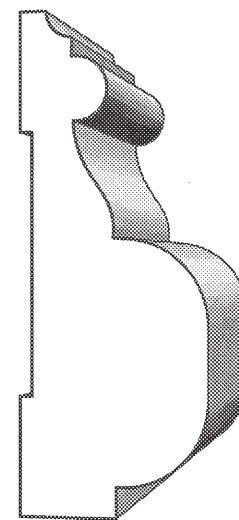

C-37
1" X 2 5/8"

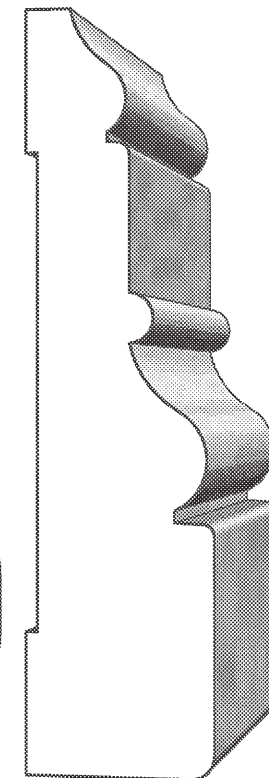

C-38
1" X 4"

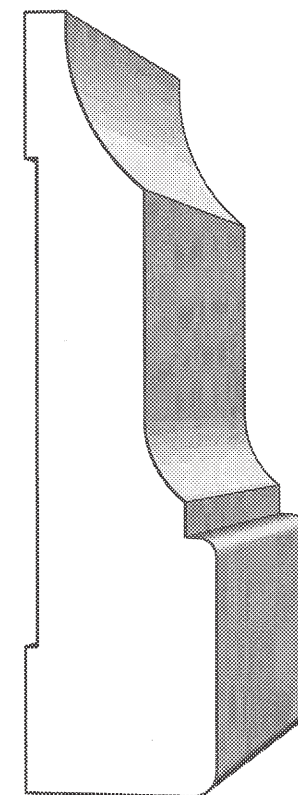

C-39
1" X 4"

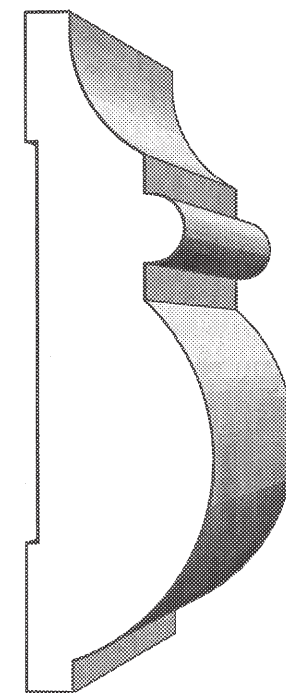

C-40
1" X 3 1/2"



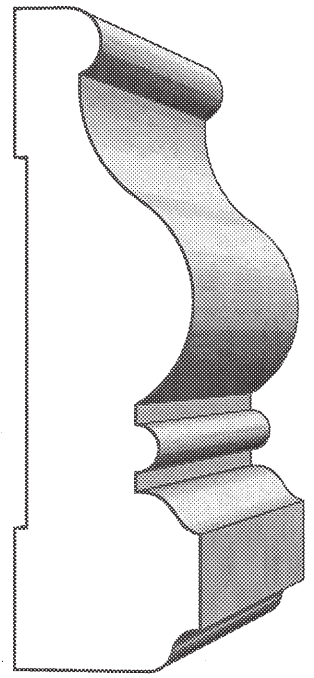

C-41
1" X 3 1/2"

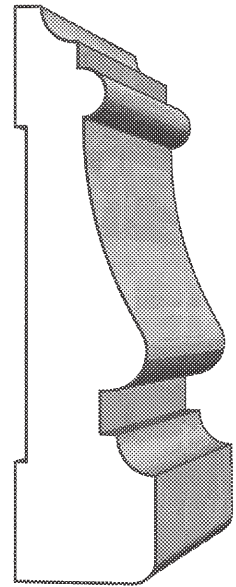

C-43
3/4" X 3"

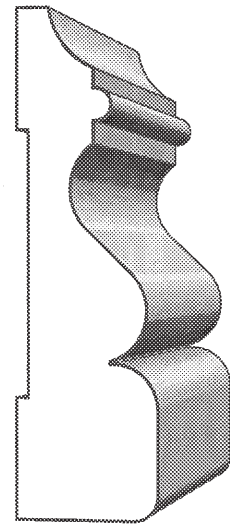

C-44
3/4" X 2 5/8"

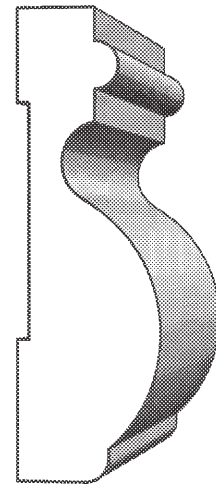

C-45
3/4" X 2 1/2"

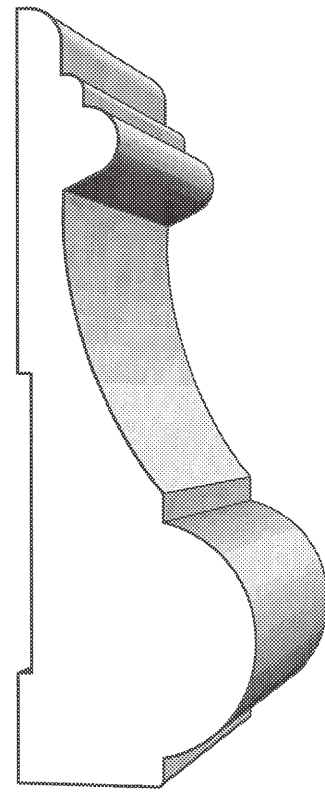

C-46
1 1/4" X 4"

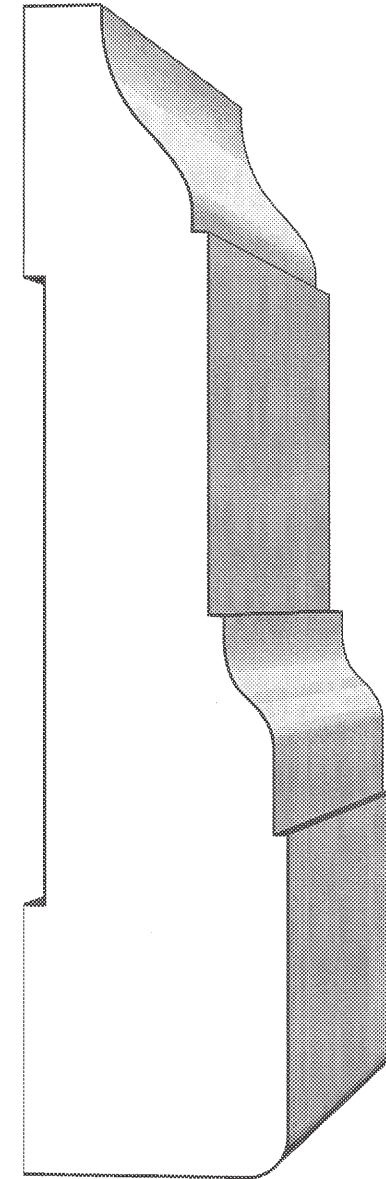

C-48
1 1/4" X *

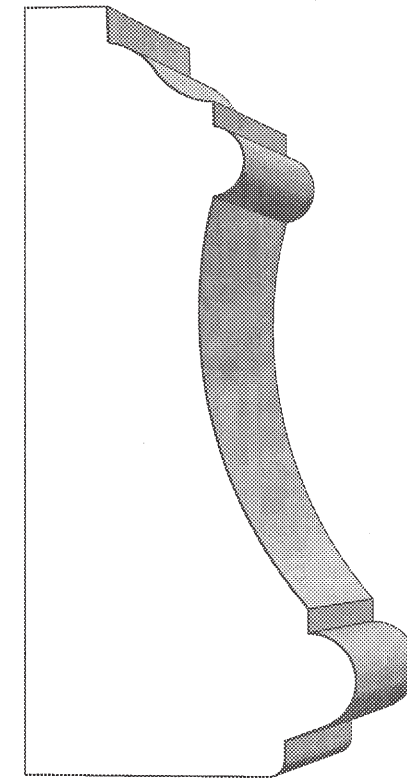

C-49
1 3/4" X 4"

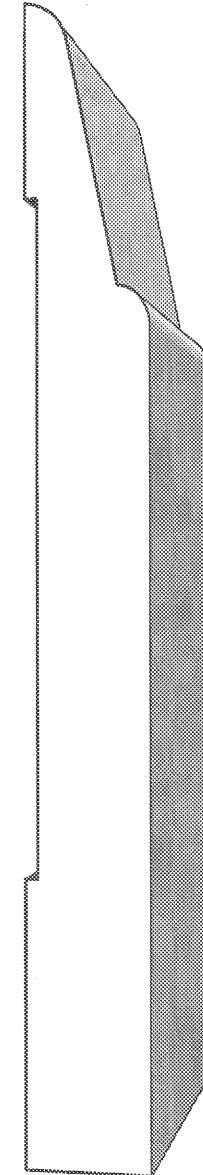

B-34
5/8" X *

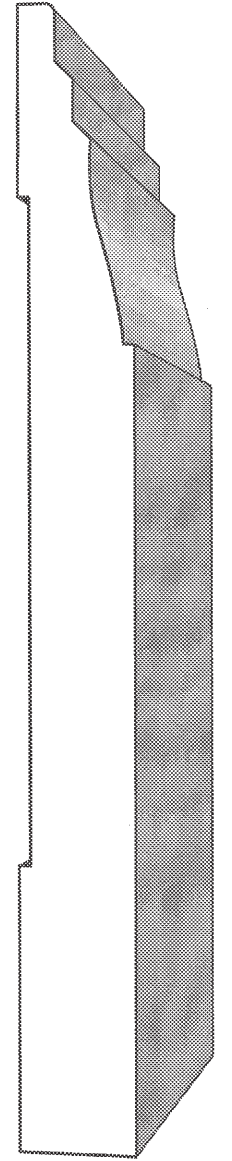

B-35
5/8" X *

* See page 0 for size options



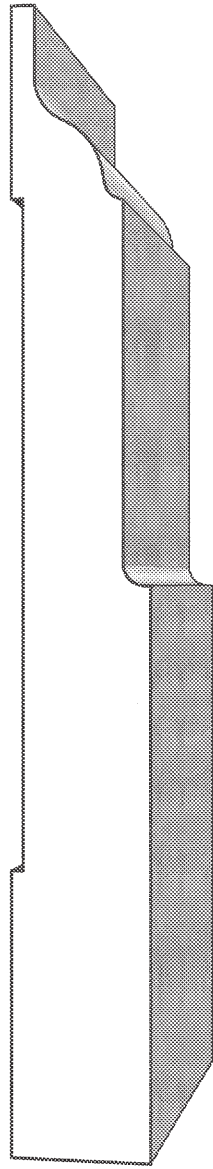

B-36
3/4" X *

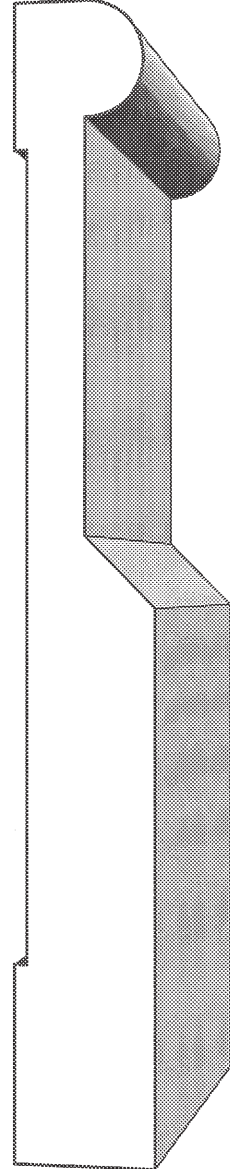

B-37
3/4" X *

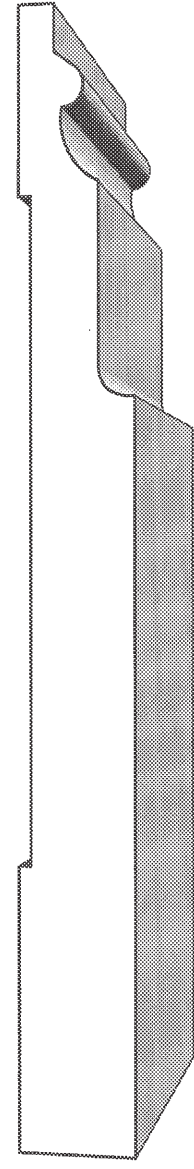

B-39
5/8" X *

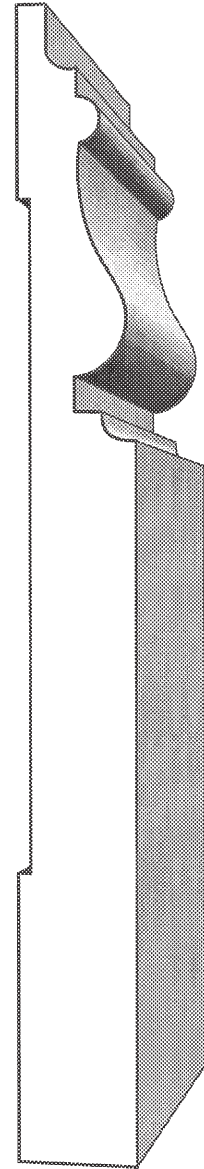

B-40
5/8" X *

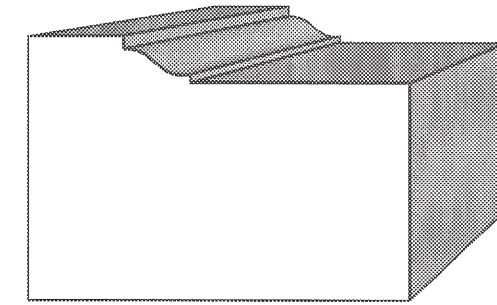

BM-01
2" X 1 3/8"

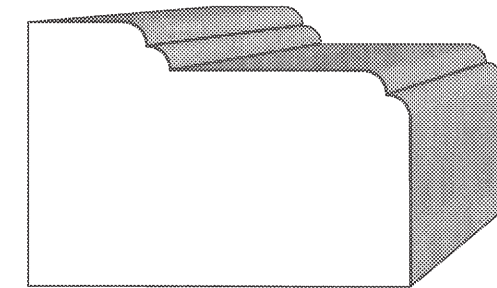

BM-02
2" X 1 3/8"

* See page 0 for size options



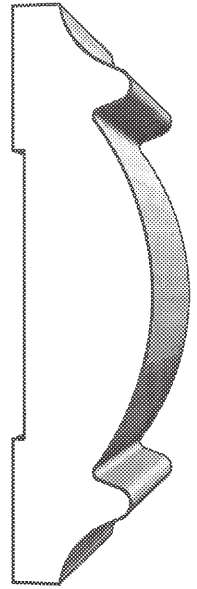

SM-1300
3/4" X 3"

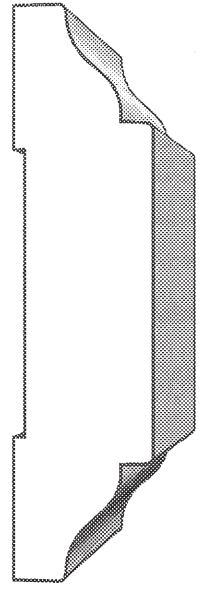

SM-2300
3/4" X 3"

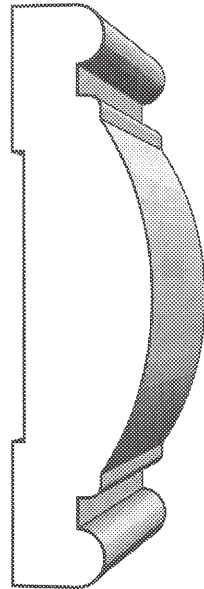

SM-3300
3/4" X 3"

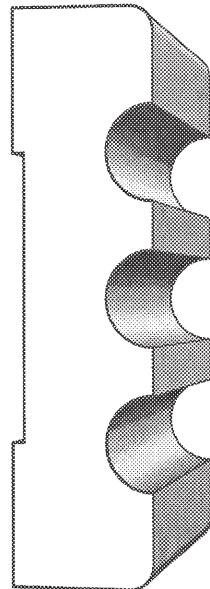

SM-4300
3/4" X 3"

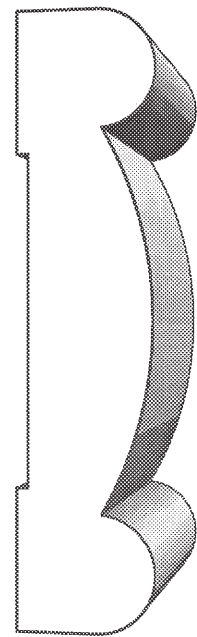

SM-1325
3/4" X 3 1/4"

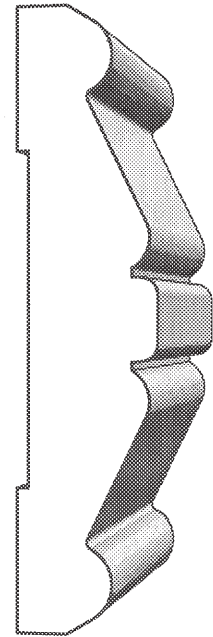

SM-2325
3/4" X 3 1/4"

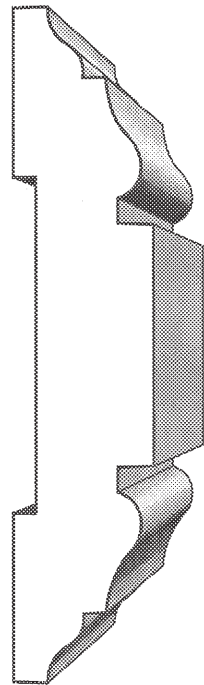

SM-1350
3/4" X 3 1/2"

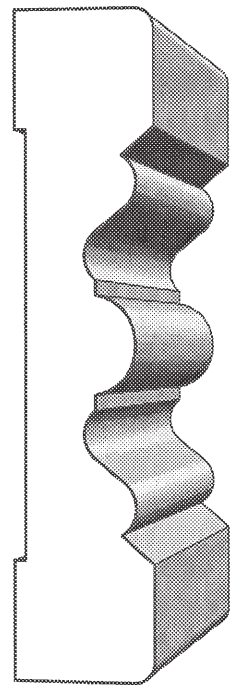

SM-2350
3/4" X 3 1/2"

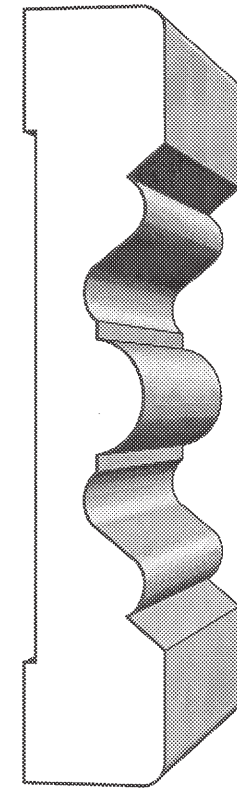

SM-1400
3/4" X 4"

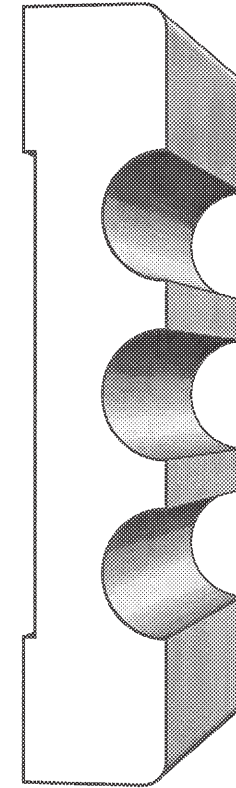

SM-2400
3/4" X 4"

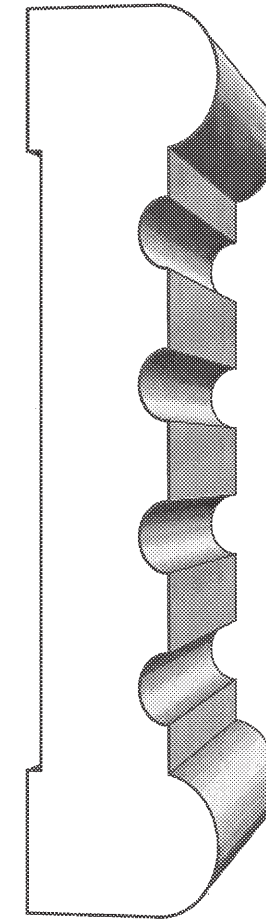

SM-1475
1" X 4 3/4"

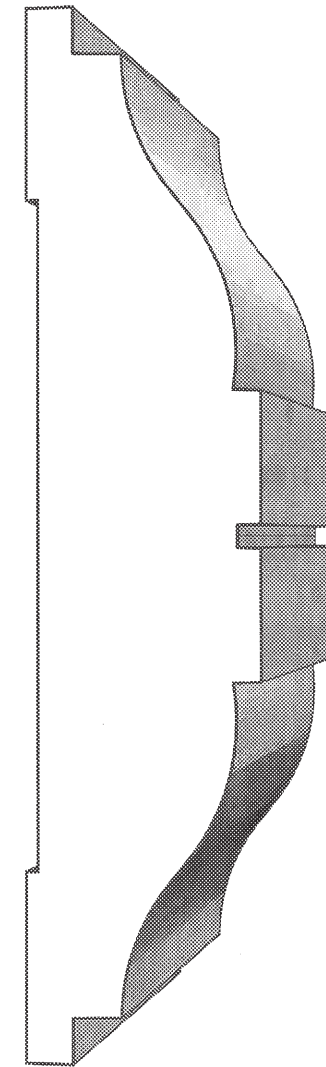

SM-1550
1 1/4" X 5 1/2"

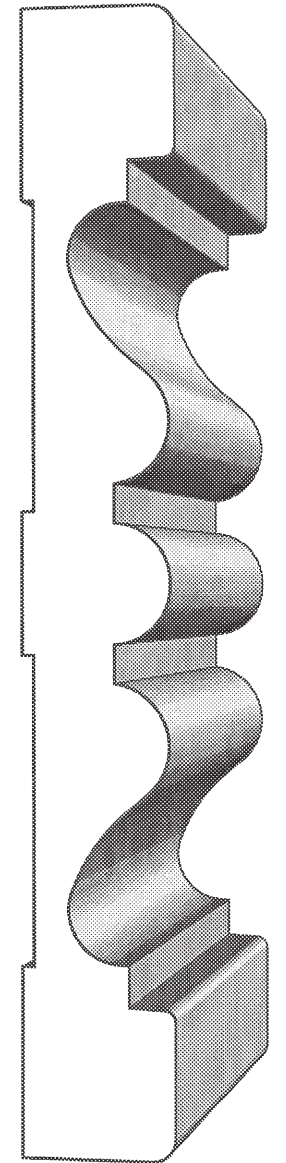

SM-1600
7/8" X 6"



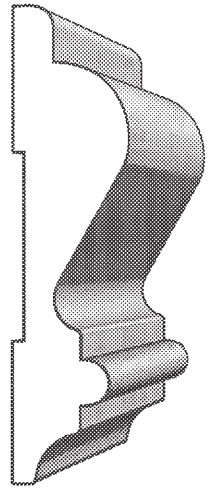

CH-1250
5/8" X 2 1/2"

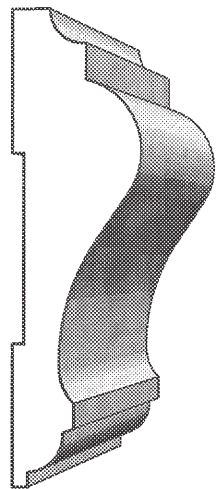

CH-2250
11/16" X 2 1/2"

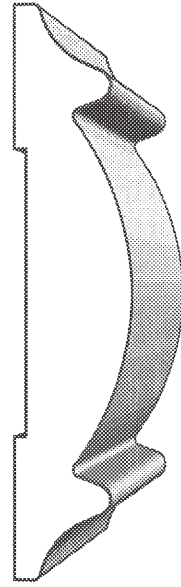

CH-1300
5/8" X 3"

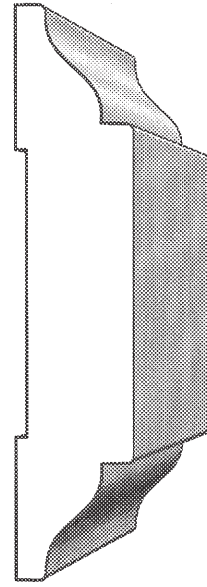

CH-2300
5/8" X 3"

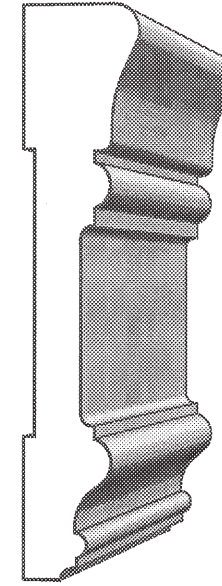

CH-7300
5/8" X 3"

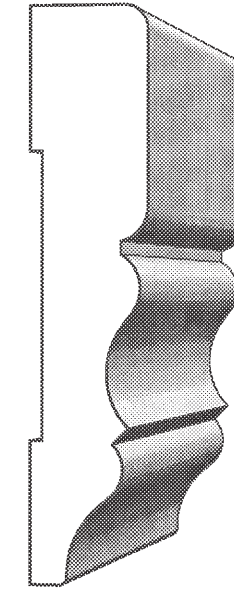

CH-8300
5/8" X 3"

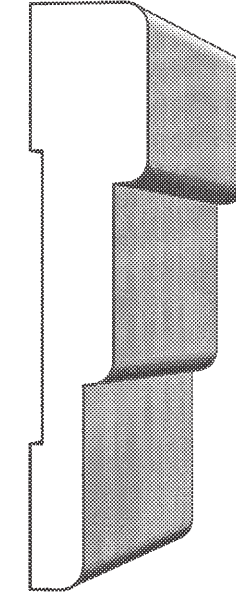

CH-9300
5/8" X 3"

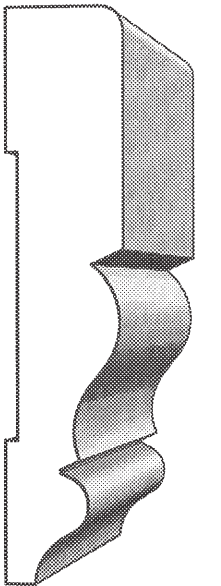

CH-10300
5/8" X 3"

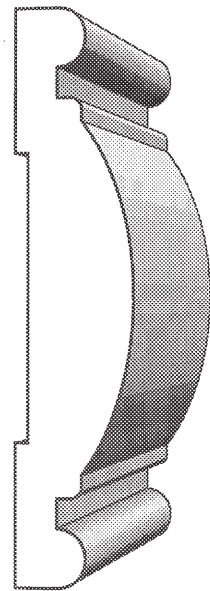

CH-3300
5/8" X 3"

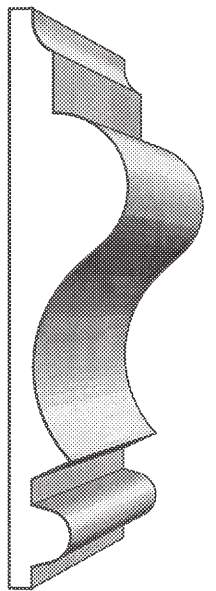

CH-4300
5/8" X 3"

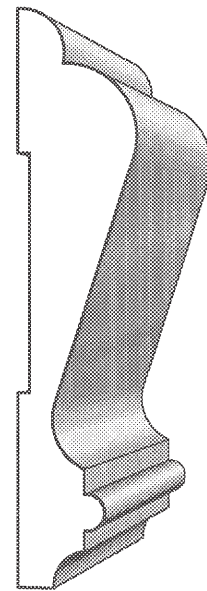

CH-5300
5/8" X 3"

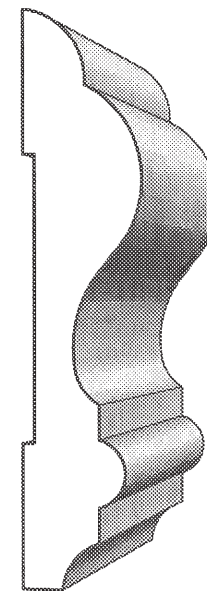

CH-6300
5/8" X 3"

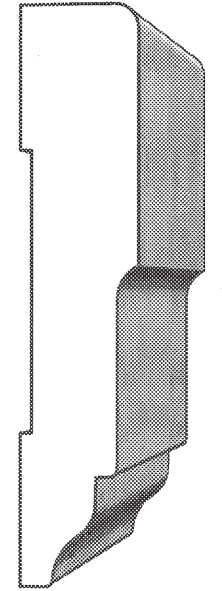

CH-11300
5/8" X 3"

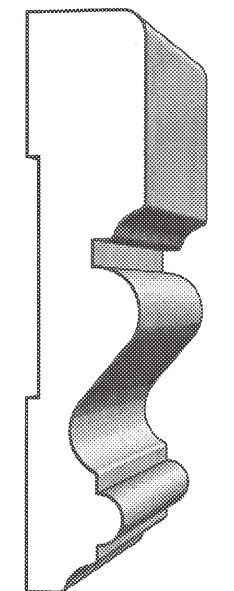

CH-12300
5/8" X 3"

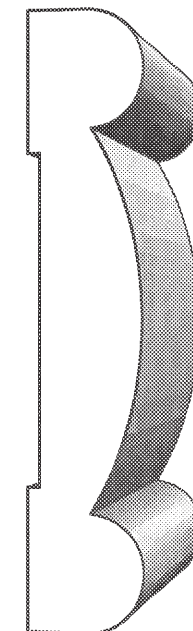

CH-1325
5/8" X 3 1/4"

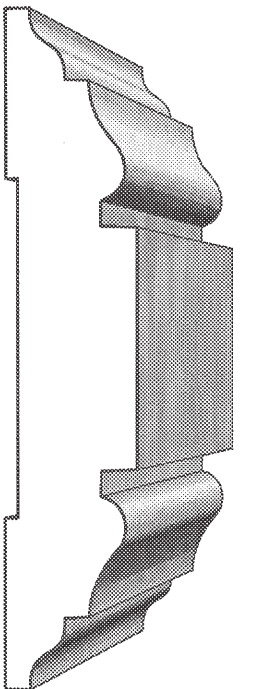

CH-1350
11/16" X 3 1/2"



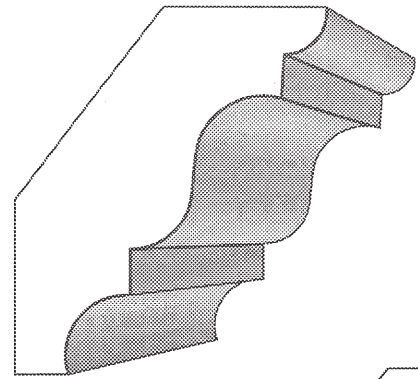

CRO-01200
3/4" X 2"

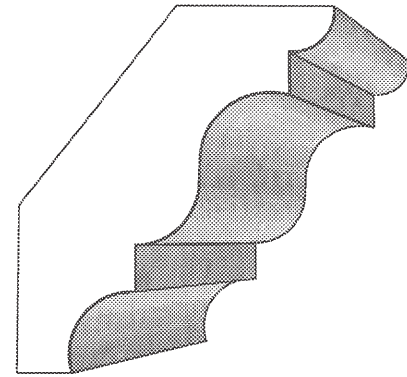

CRO-01250
3/4" X 2 1/2"

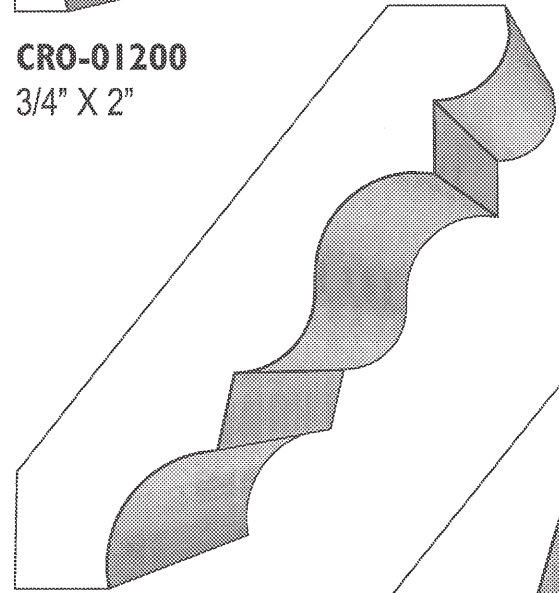

CRO-01400
3/4" X 4"



CRO-01550
3/4" X 5 1/2"

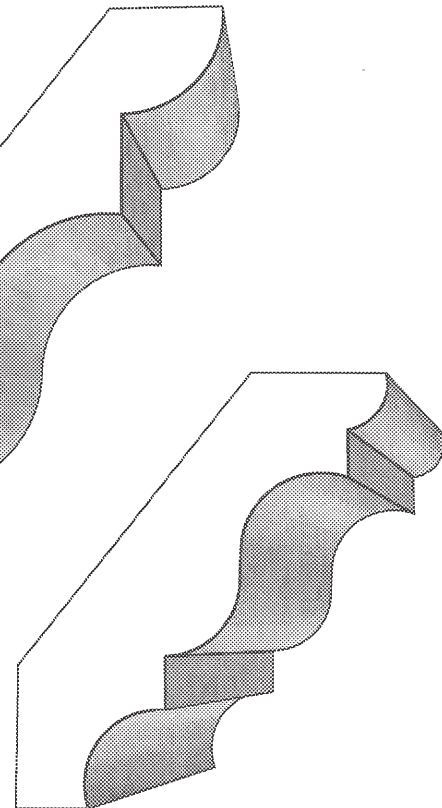

CRO-01300
3/4" X 3"

CRO-01700
13/16" X 7"

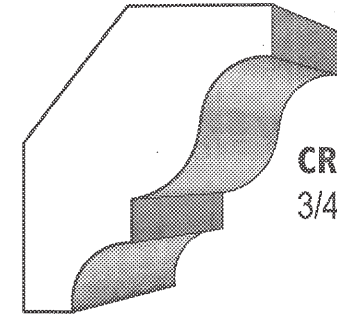

CRO-02200
3/4" X 2"

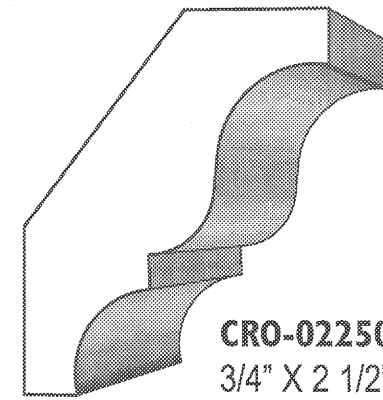

CRO-02250
3/4" X 2 1/2"

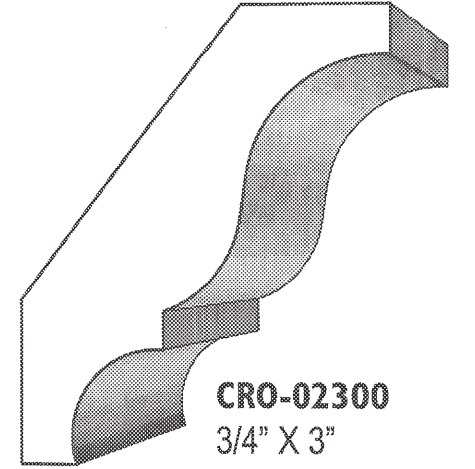

CRO-02300
3/4" X 3"

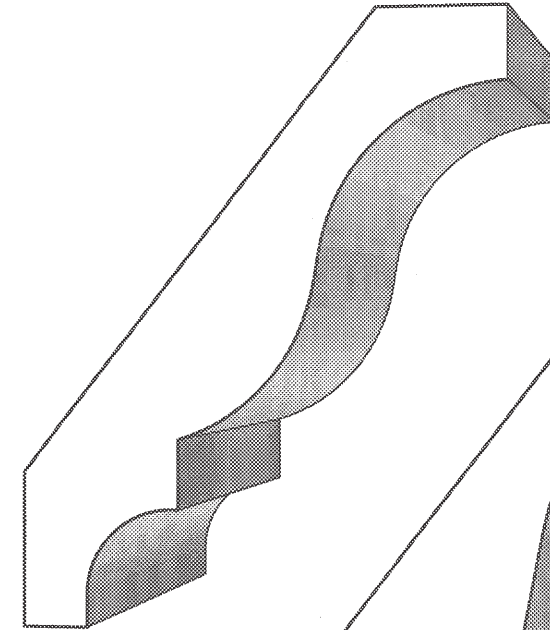

CRO-02400
3/4" X 4"

CRO-02400
3/4" X 4"

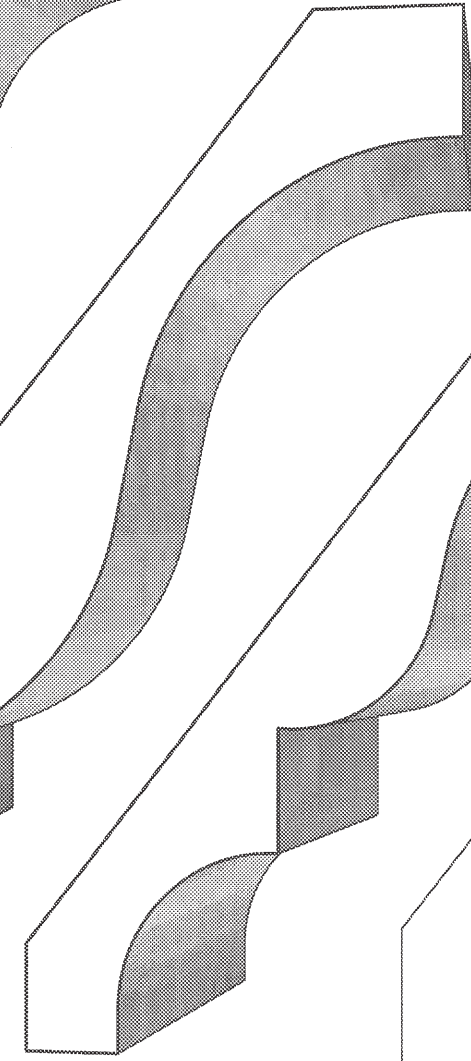

CRO-02550
3/4" X 5 1/2"



CRO-02450
3/4" X 4 1/2"

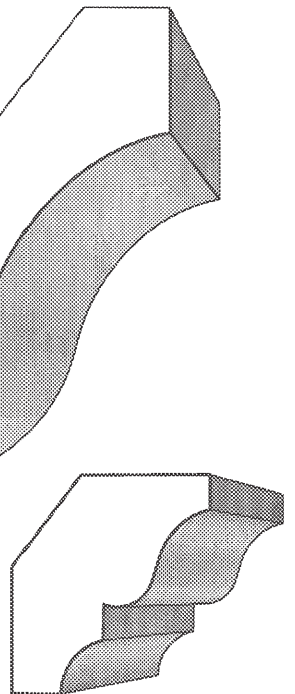

CRO-02150
5/8" X 1 1/2"

CRO-02700
1" X 7"



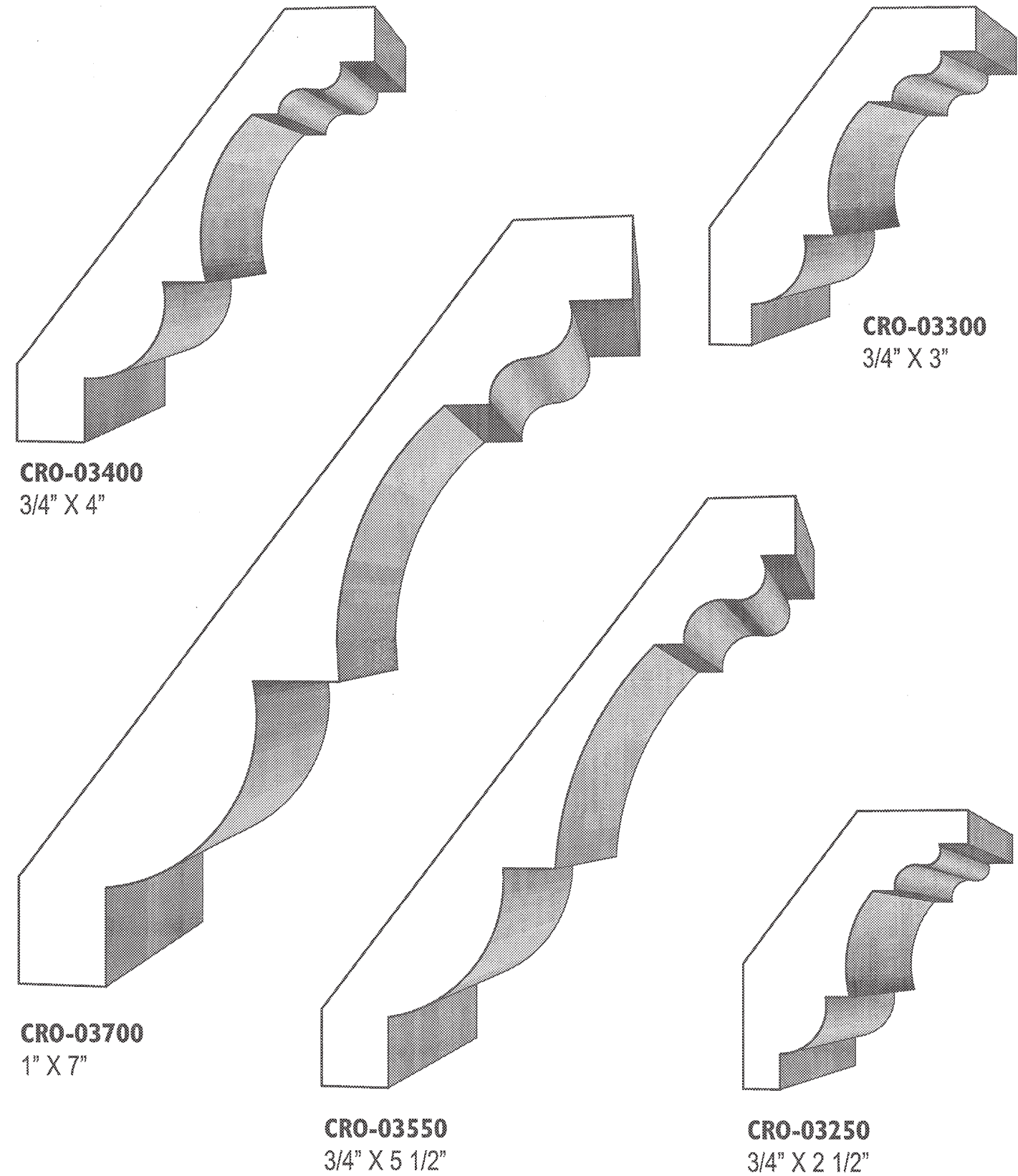

CRO-03400
3/4" X 4"

CRO-03700
1" X 7"

CRO-03550
3/4" X 5 1/2"

CRO-03250
3/4" X 2 1/2"

CRO-03300
3/4" X 3"

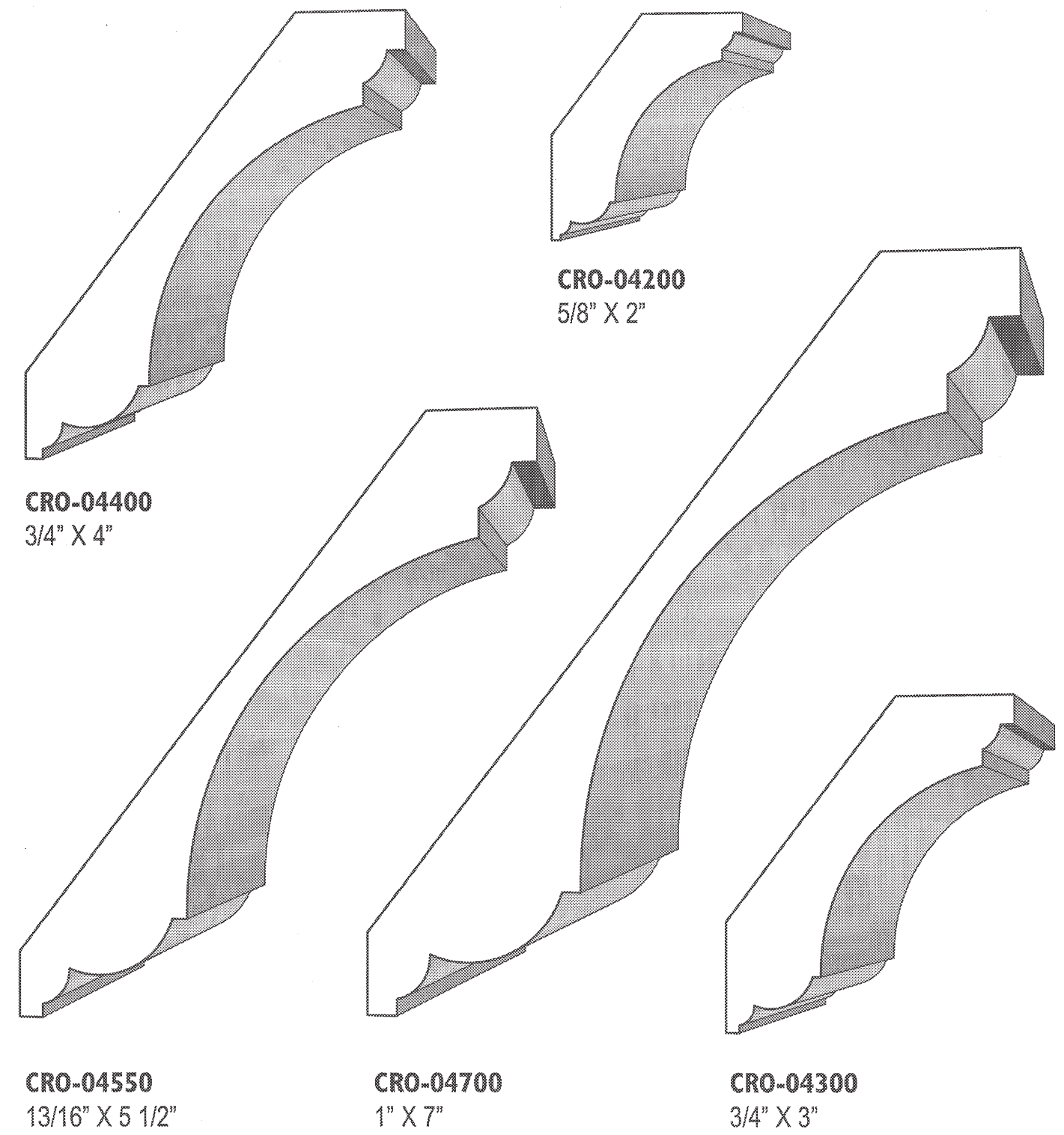

CRO-04400
3/4" X 4"

CRO-04550
13/16" X 5 1/2"

CRO-04700
1" X 7"

CRO-04300
3/4" X 3"

CRO-04200
5/8" X 2"



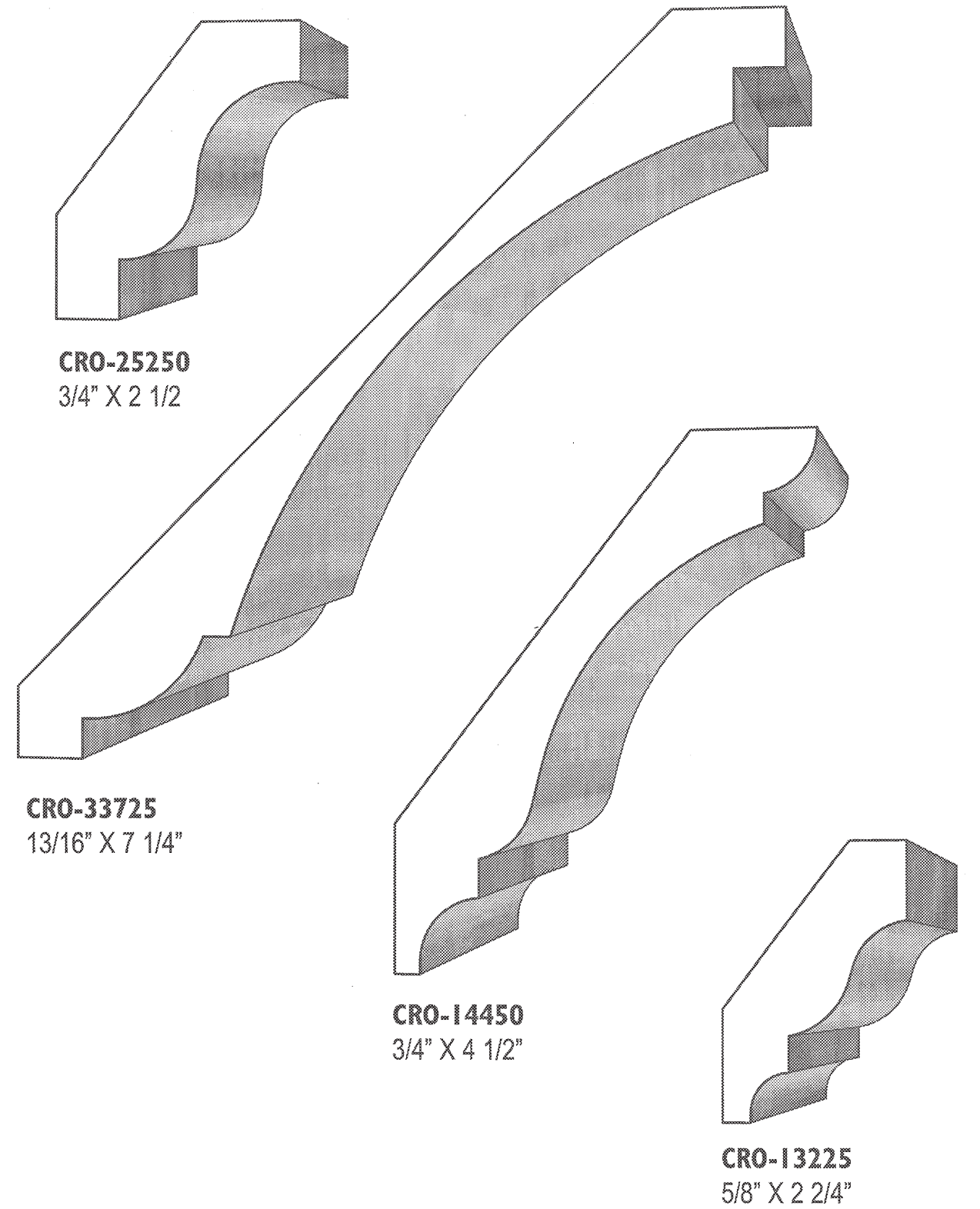
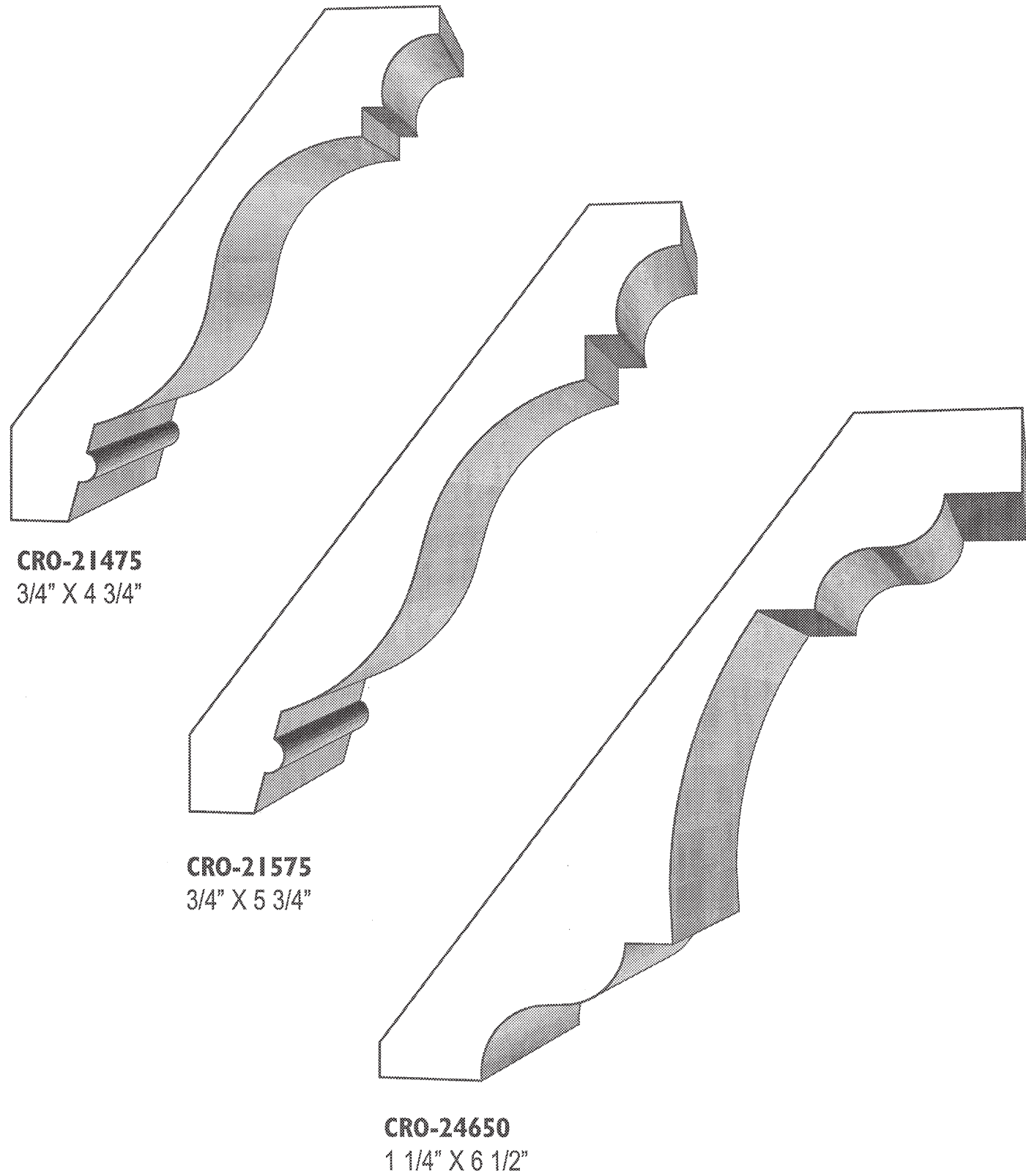

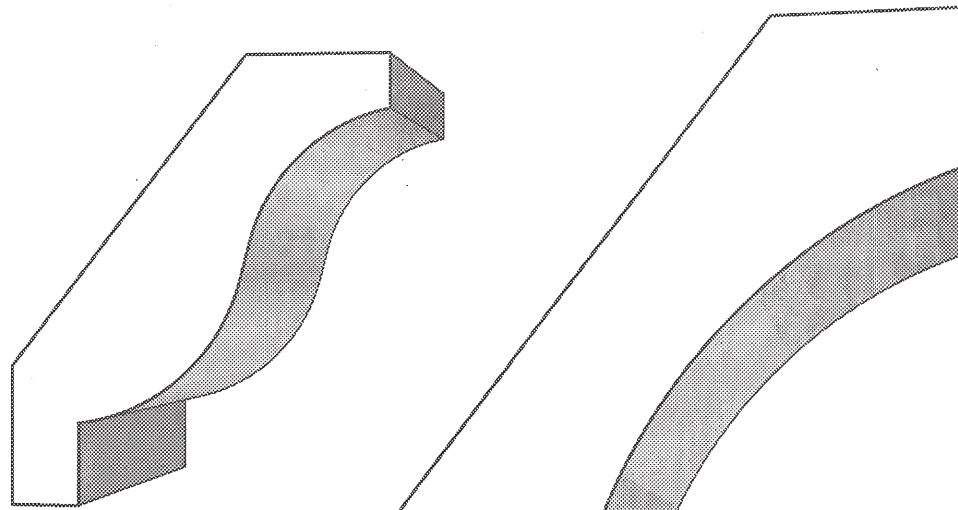

CRO-26300
3/4" X 3"

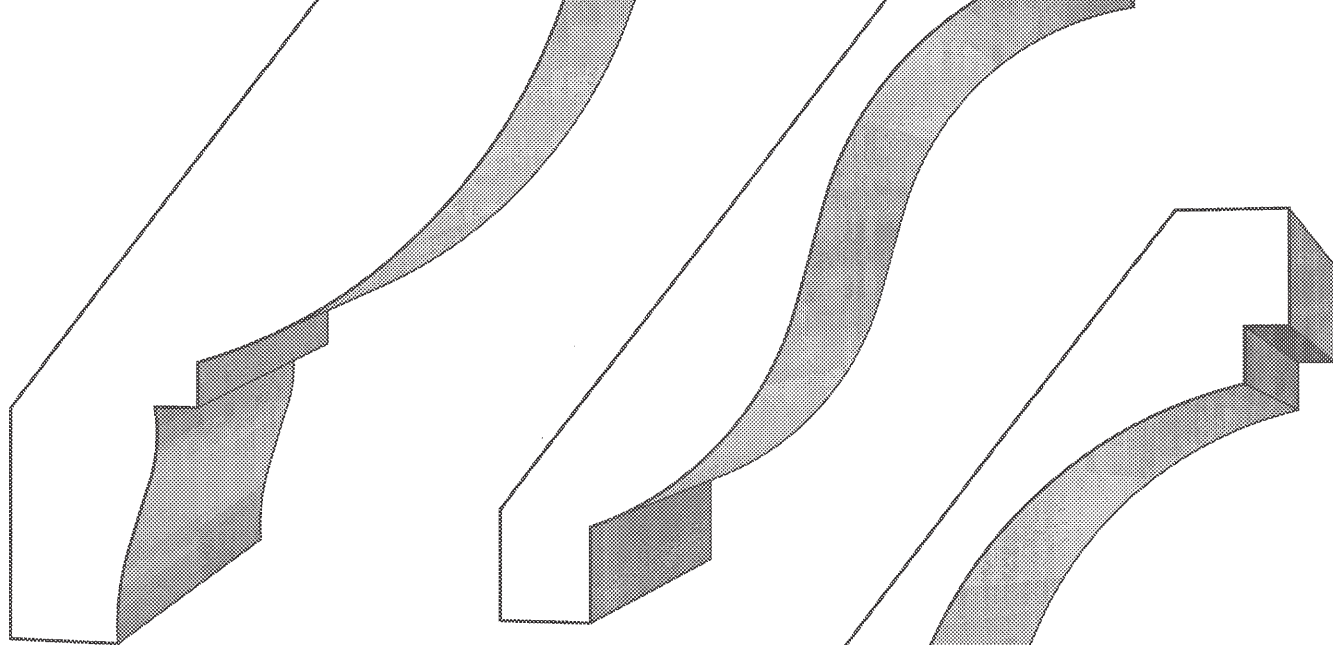

CRO-28825
1" X 8 1/4"



CRO-27500
3/4" X 5"

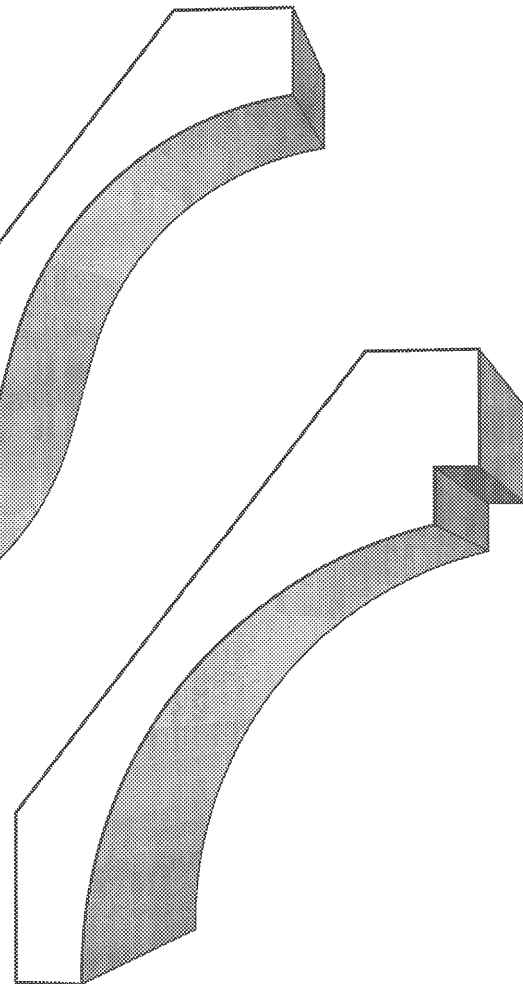

CRO-29400
13/16" X 4"

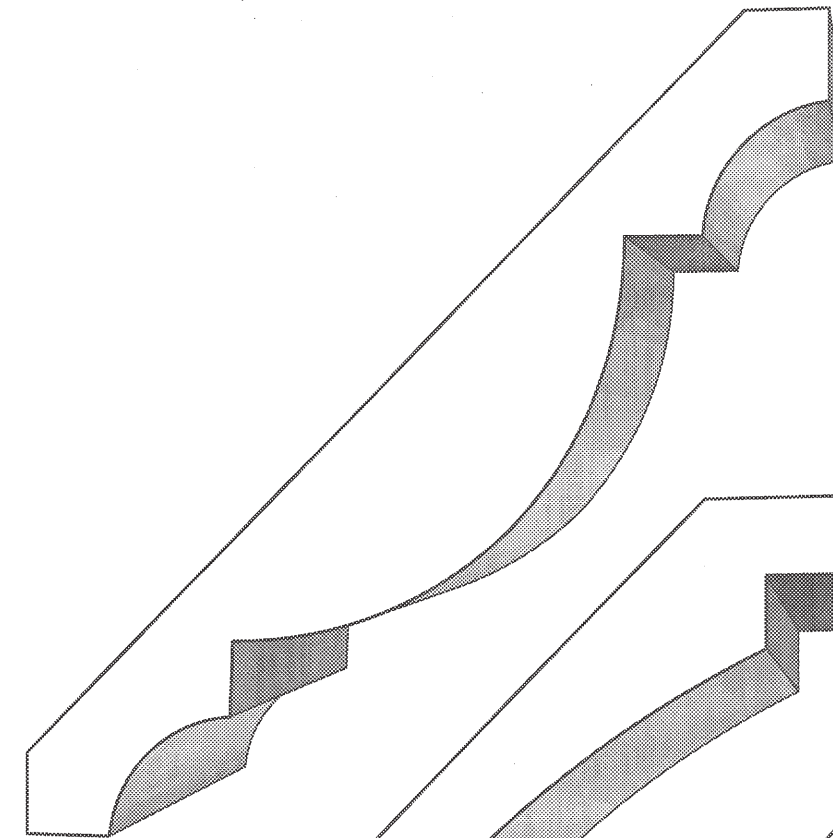

CRO-19600
1" X 6"

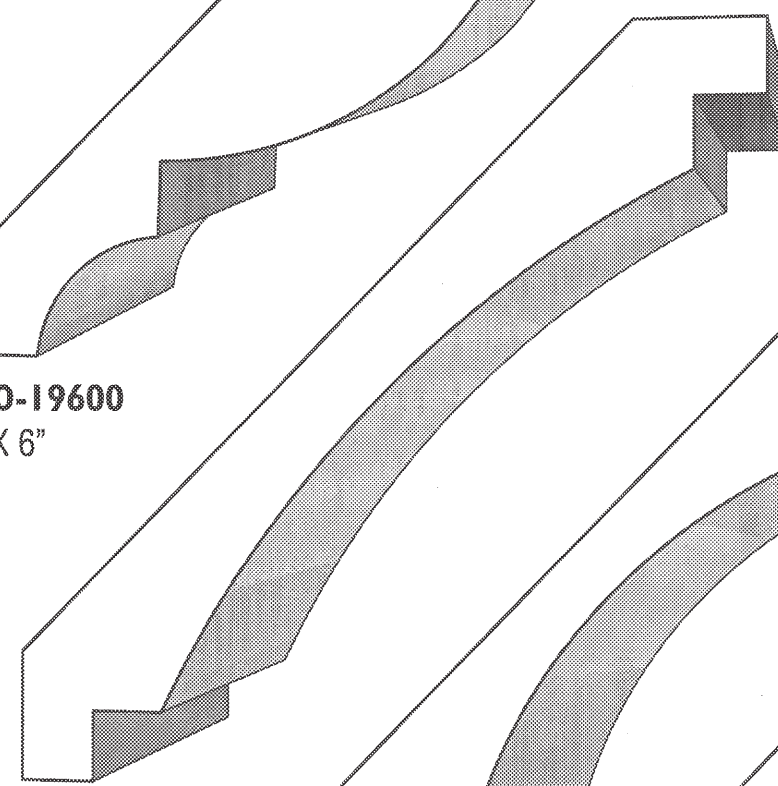

CRO-30550
3/4" X 5 5/8"

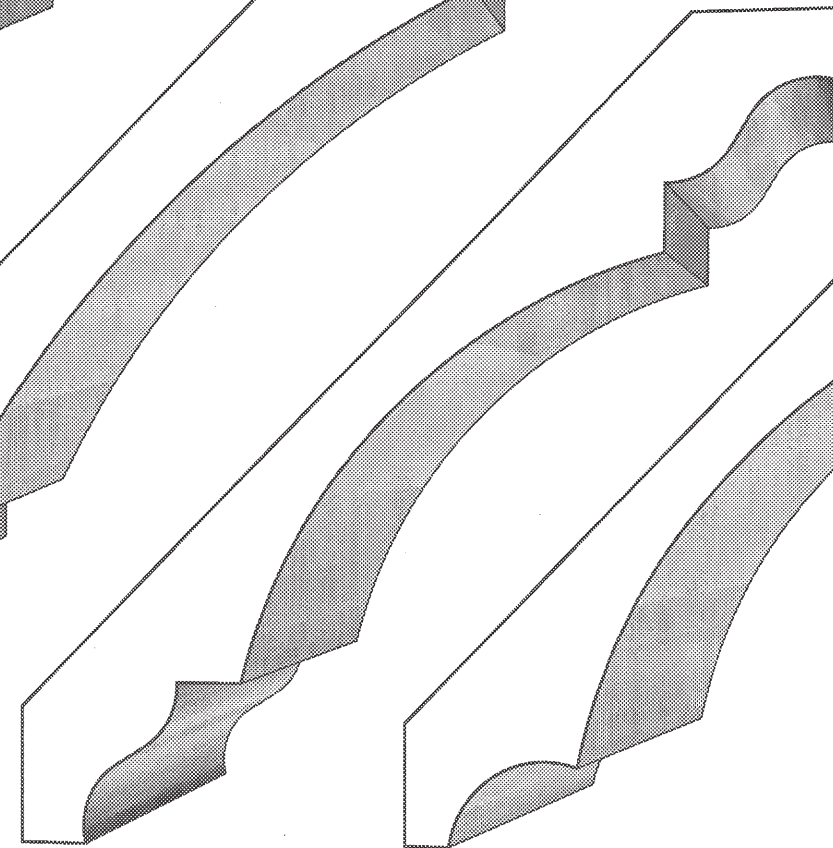

CRO-32600
3/4" X 6"

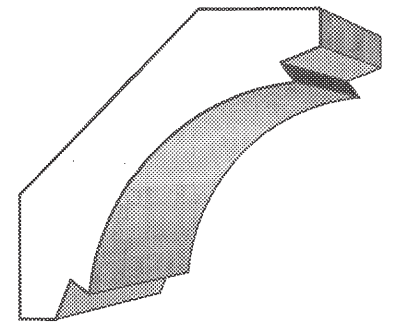

CRO-20225
5/8" X 2 1/4"

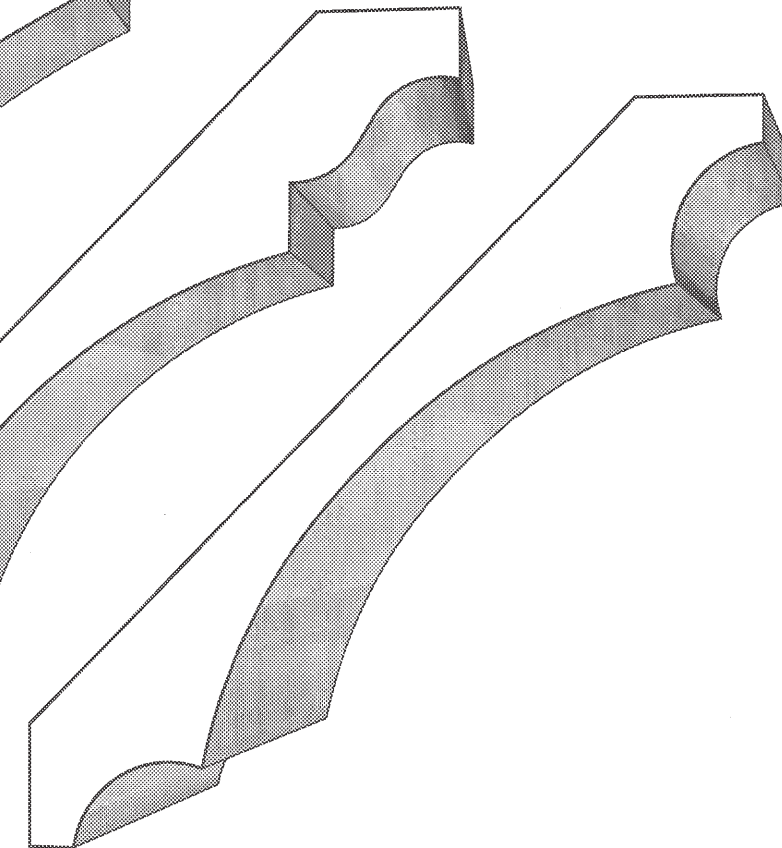

CRO-18500
3/4" X 5 1/2"



CROWN - BED MOLD

COVE MOLDING

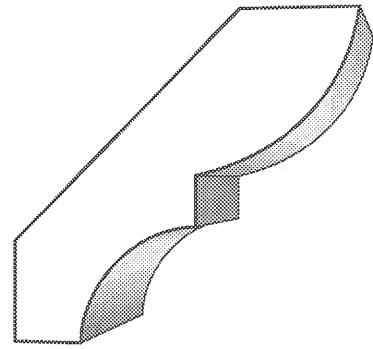

BED-1250
5/8" X 2 1/2"

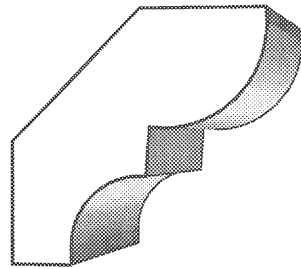

BED-11750
5/8" X 1 3/4"

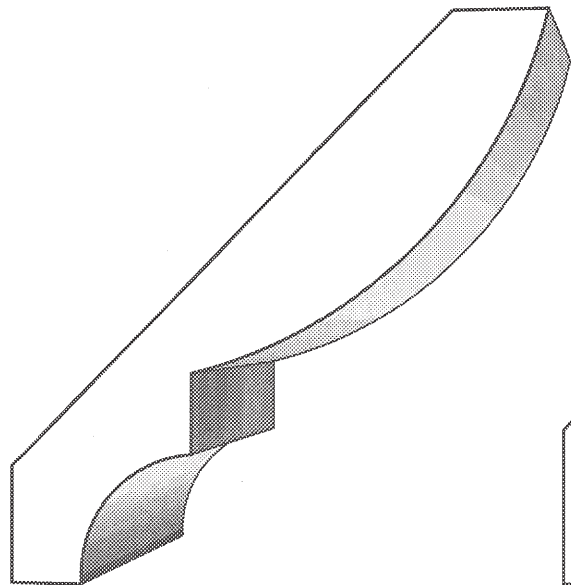

BED-1400
5/8" X 4"

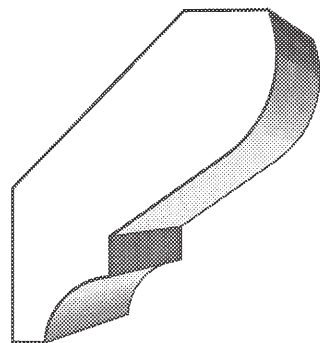

BED-2200
5/8" X 2"

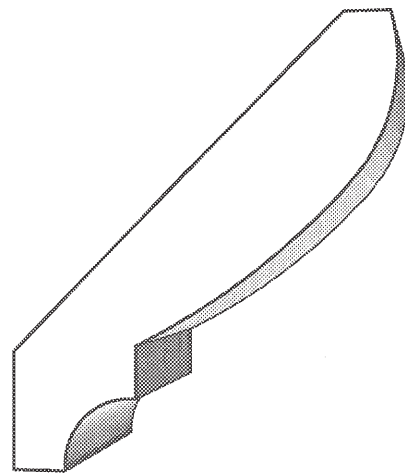

BED-2300
5/8" X 3"

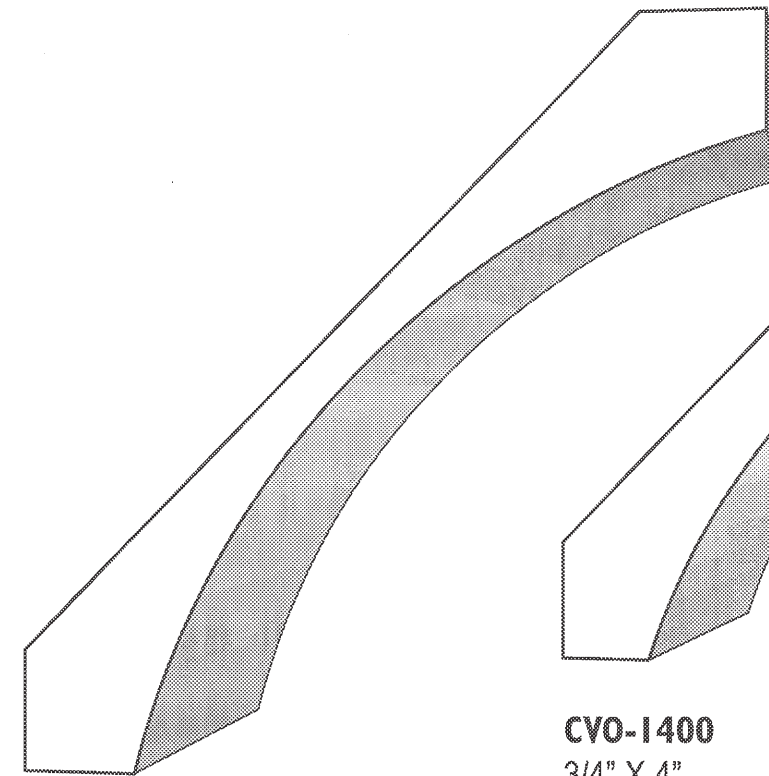

CVO-1550
7/8" X 5 1/2"

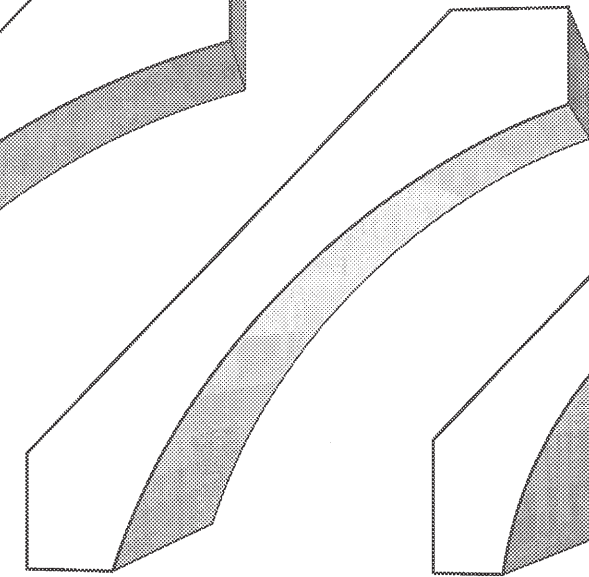

CVO-1400
3/4" X 4"

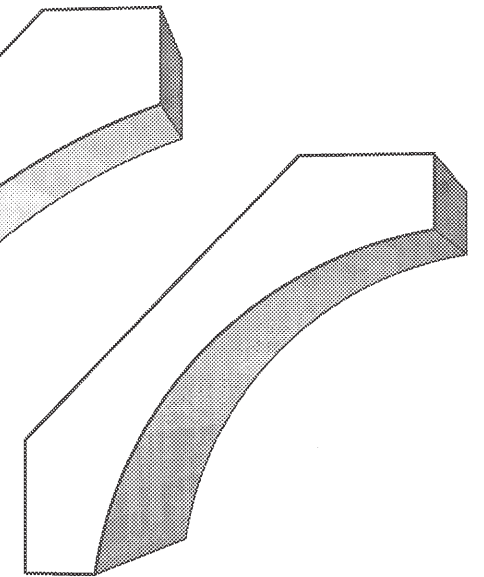

CVO-1300
3/4" X 3"

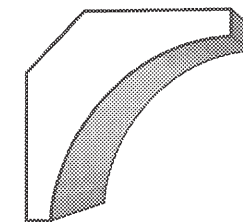

CVO-1150
5/8" X 1 1/2"

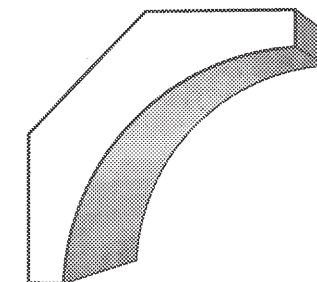

CVO-1200
1 1/16" X 2"

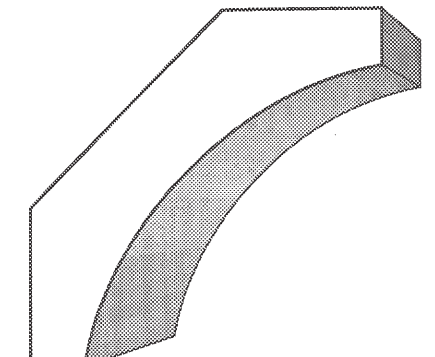

CVO-1250
3/4" X 2 1/2"

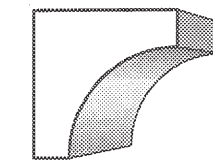

CVO-2750
3/4" X 3/4"

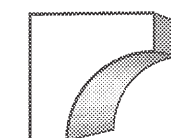

CVO-2625
5/8" X 5/8"

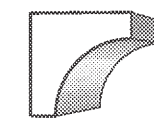

CVO-2500
1/2" X 1/2"

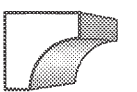

CVO-2375
3/8" X 3/8"



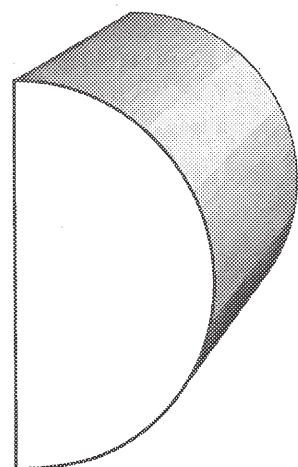

HR-200
1" X 2"

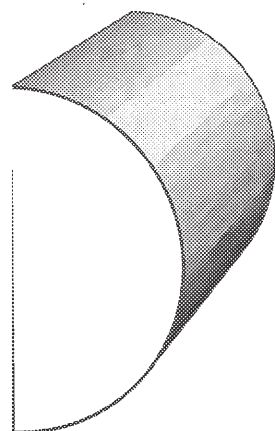

HR-175
7/8" X 1 3/4"

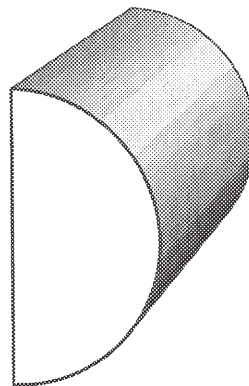

HR-150
3/4" X 1 1/2"

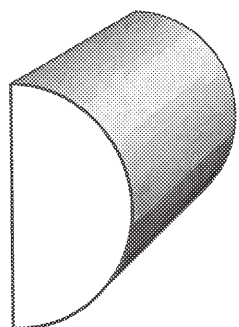

HR-125
5/8" X 1 1/4"

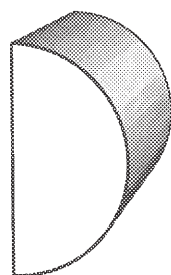

HR-1125
7/16" X 1 1/8"

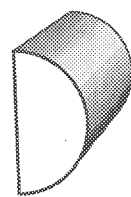

HR-750
3/8" X 3/4"

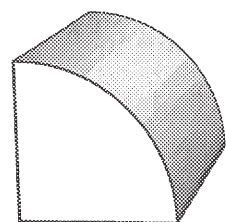

QR-750
3/4" X 3/4"

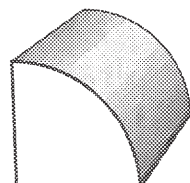

QR-625
5/8" X 5/8"

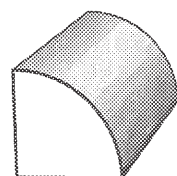

QR-500
1/2" X 1/2"

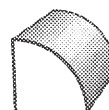

QR-375
3/8" X 3/8"

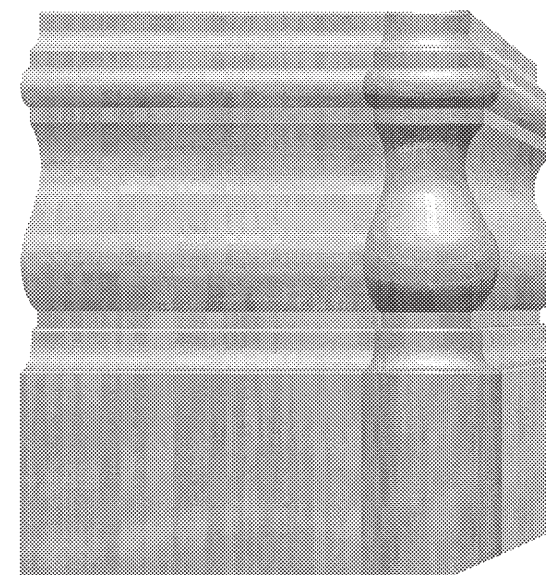

**Profiled Radius Corners to Match
Base and Chair-Rail**

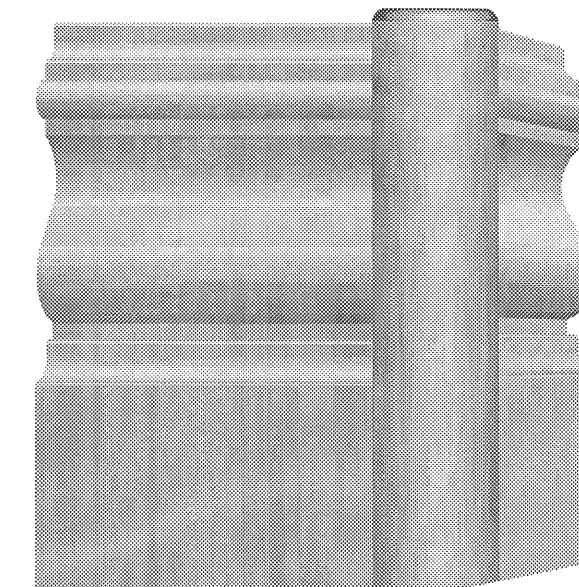

**Radius Corner - Blocks
Sized to Match Base Moulding**

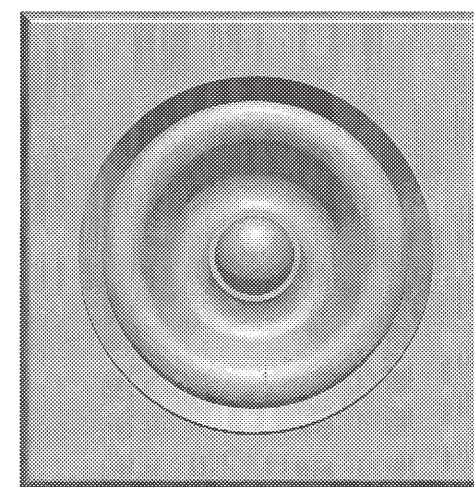

**Corner Blocks
Sized to Order**

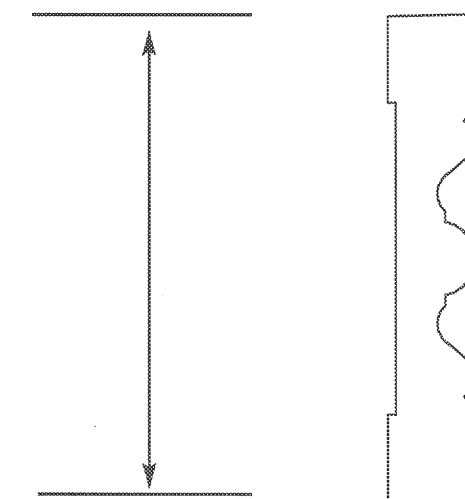

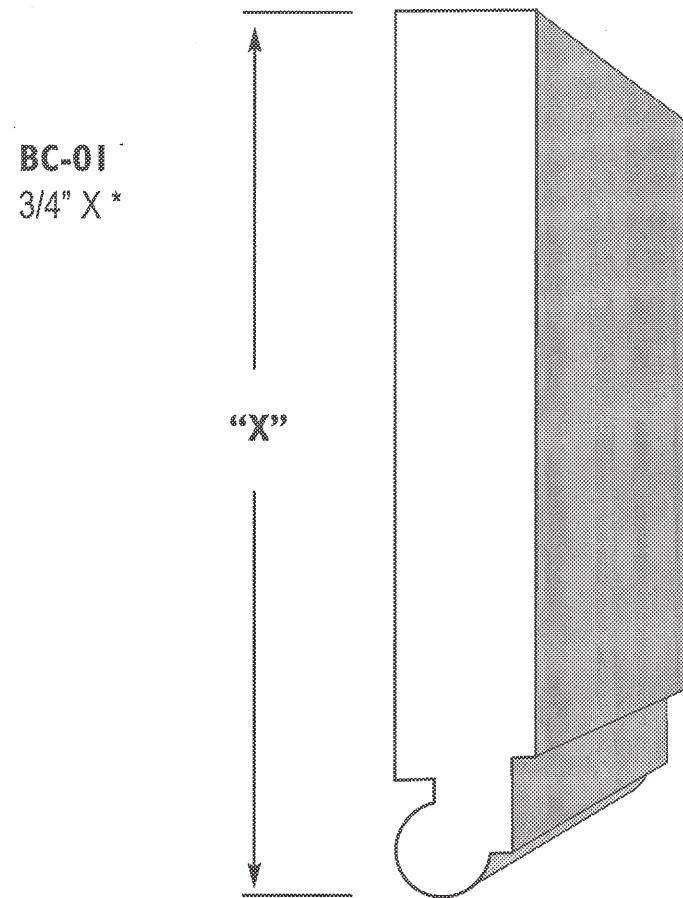

BC-01
3/4" X *

"X"

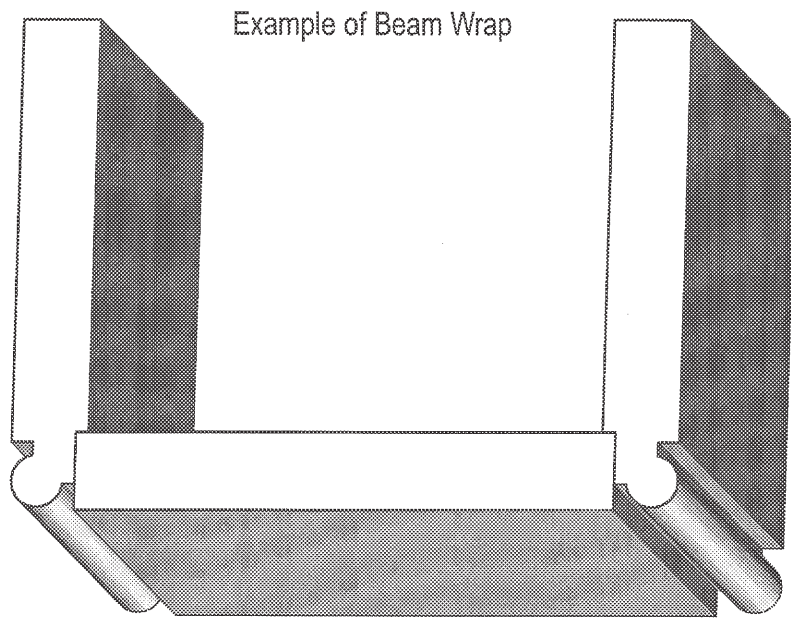

Example of Beam Wrap

* See page 0 for size options.

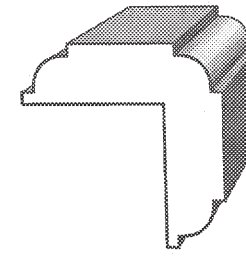

OS-02750
1 1/16" X 1 1/16"

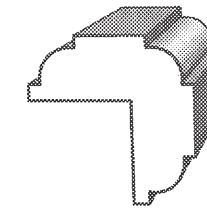

OS-02500
7/8" X 7/8"

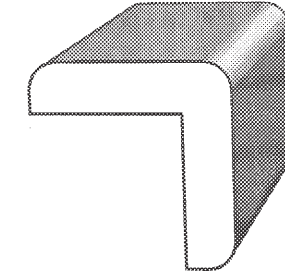

OS-01750
1" X 1"

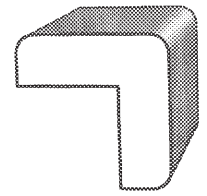

OS-01500
3/4" X 3/4"

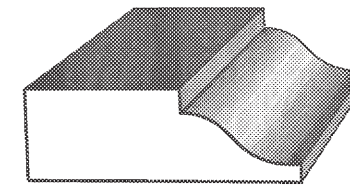

STO1-150
1/2" X 1 1/2"

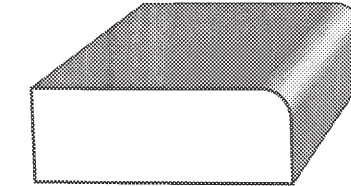

STO2-1375
1/2" X 1 3/8"

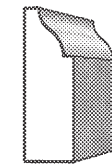

SCR-01750
1/4" X 3/4"

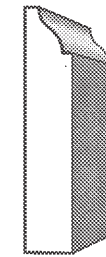

SCR-01125
1/4" X 1 1/4"



SCR-02750
1/4" X 3/4"

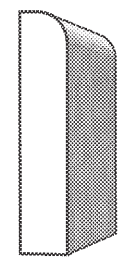

SCR-02125
1/4" X 1 1/4"

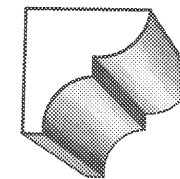

CM-01
5/8" X 5/8"

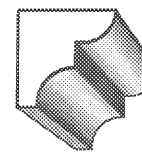

CM-02
1/2" X 1/2"

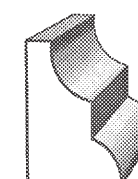

BS-01
1/2" X 3/4"

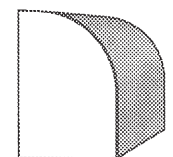

BS-02
1/2" X 3/4"



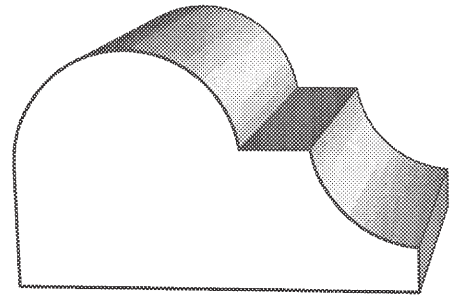

BN-01
1 1/4" X 2 1/8"

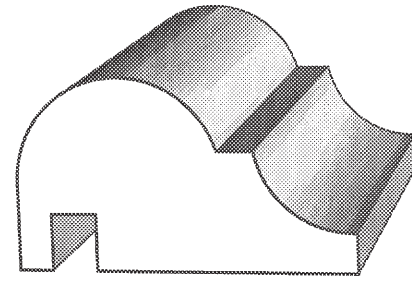

TCN-01
1 1/16" X 1 7/8"

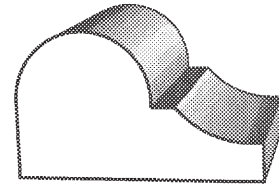

BN-02
3/4" X 1 1/4"

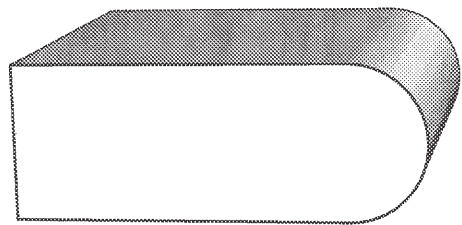

BN-03
3/4" X Up to 8 1/2"

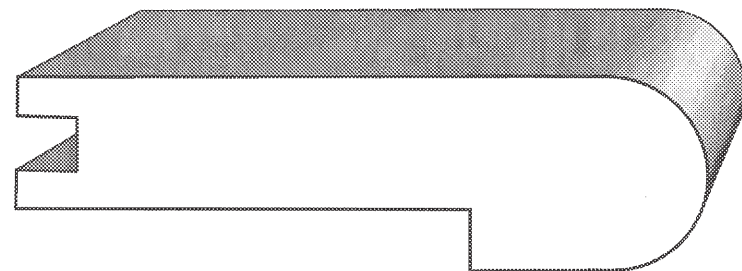

BN-04
1" X 3 1/2"

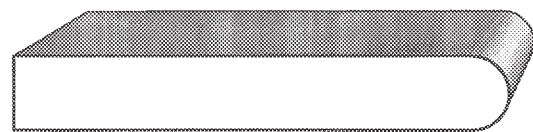

BN-05
3/8" X Up to 8 1/2"

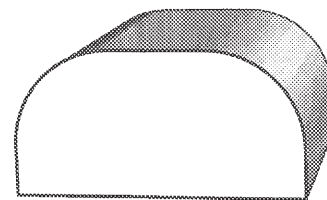

BN-06
3/4" X 1 1/2"

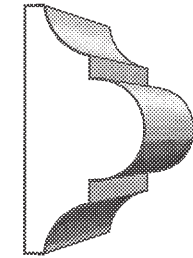

PO-2125
5/8" X 1 1/4"

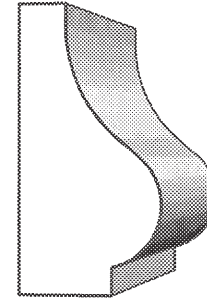

PO-5150
3/4" X 1 1/2"

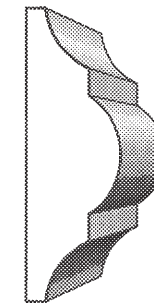

PO-1150
1/2" X 1 1/2"

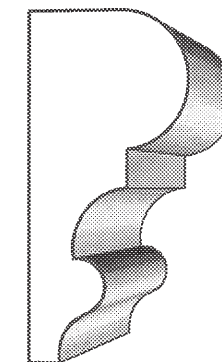

PO-10175
13/16" X 1 3/4"

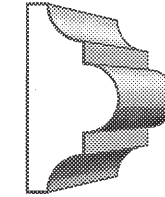

PO-8100
1/2" X 1"

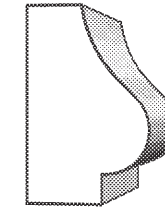

PO-5100
5/8" X 1"

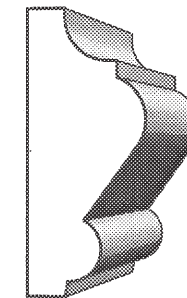

PO-6150
5/8" X 1 1/4"

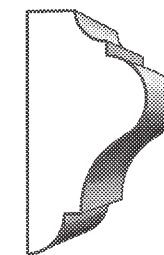

PO-7125
5/8" X 1 1/4"

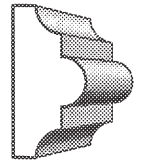

PO-9075
3/8" X 3/4"

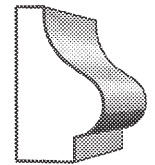

PO-5075
7/16" X 3/4"

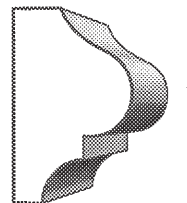

PO-4100
5/8" X 1 1/4"



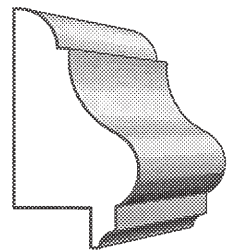

PN-02500
13/16" X 1 1/4"

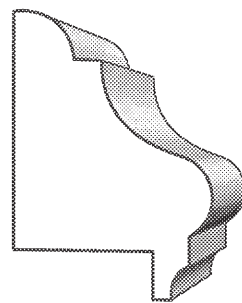

PN-02750
1 1/16" X 1 1/2"

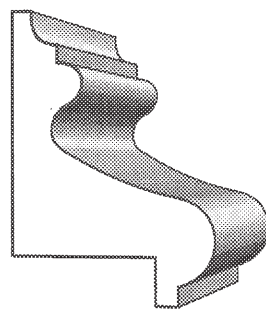

PN-01750
1 1/16" X 1 1/2"

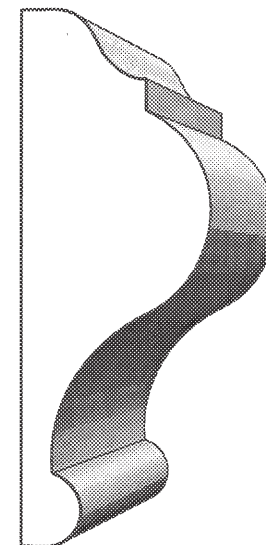

PO-12275
1" X 2 3/4"

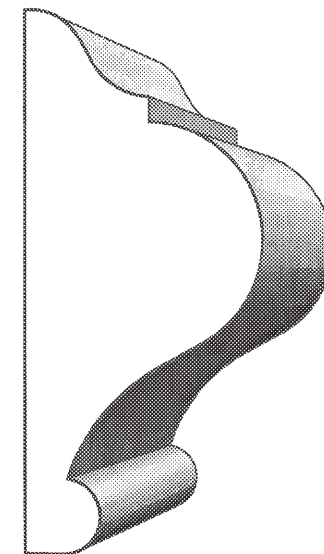

PO-12225
1" X 2 1/4"

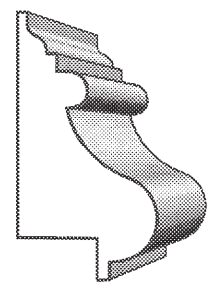

PN-03500
7/8" X 1 5/8"

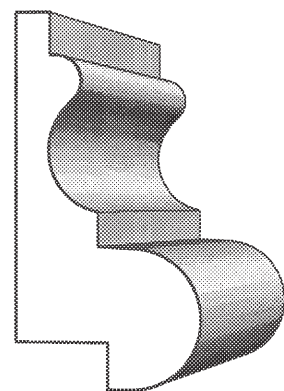

PN-08500
1" X 2"

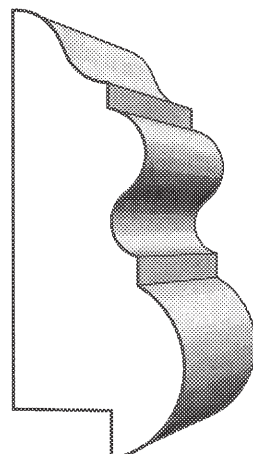

PN-09500
7/8" X 2 1/4"

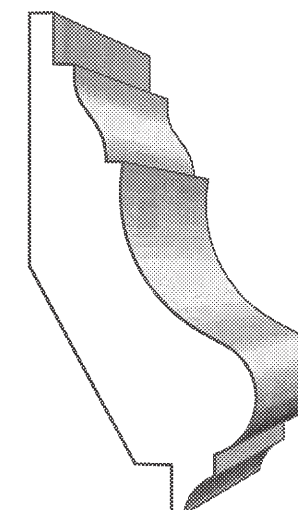

PN-04750
1 3/16" X 2 9/16"

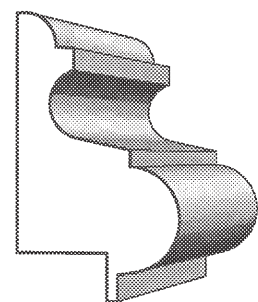

PN-07500
7/8" X 1 1/2"

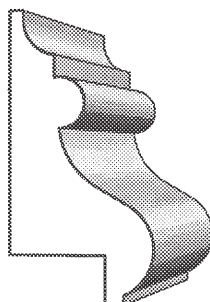

PN-01500
3/4" X 1 1/2"

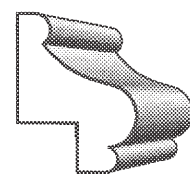

PN-06025
5/8" X 13/16"

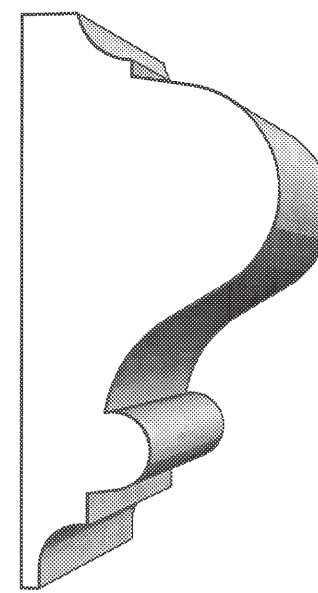

PO-13300
1 3/8" X 3"

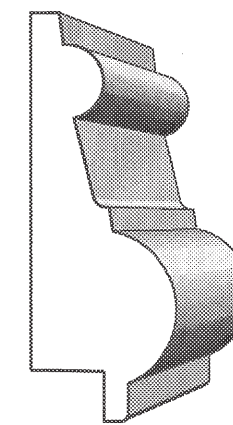

PN-05375
3/4" X 2 1/16"



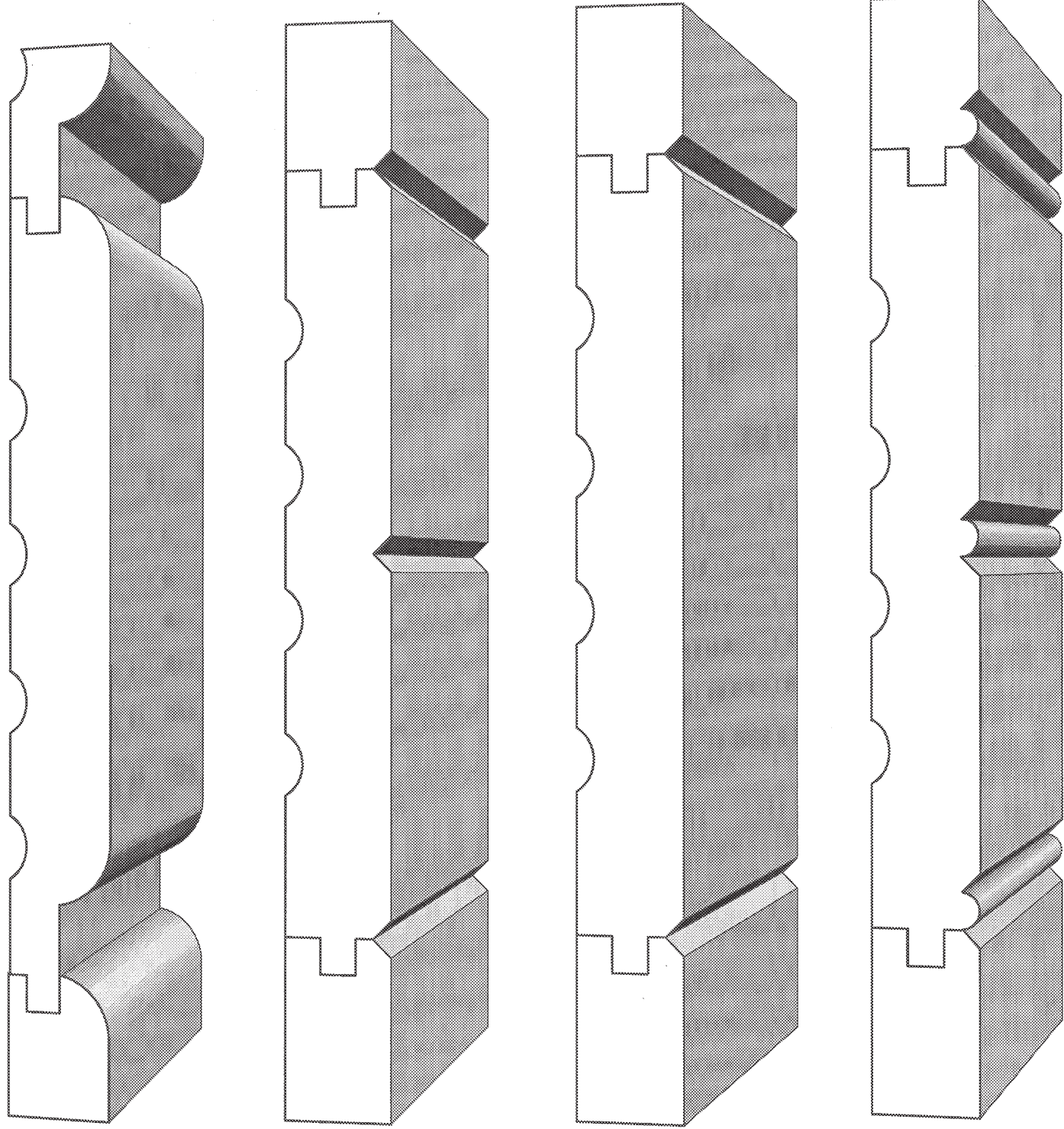

TG-001
3/4" X *

TG-002
3/4" X *

TG-003
3/4" X *

TG-004
3/4" X *

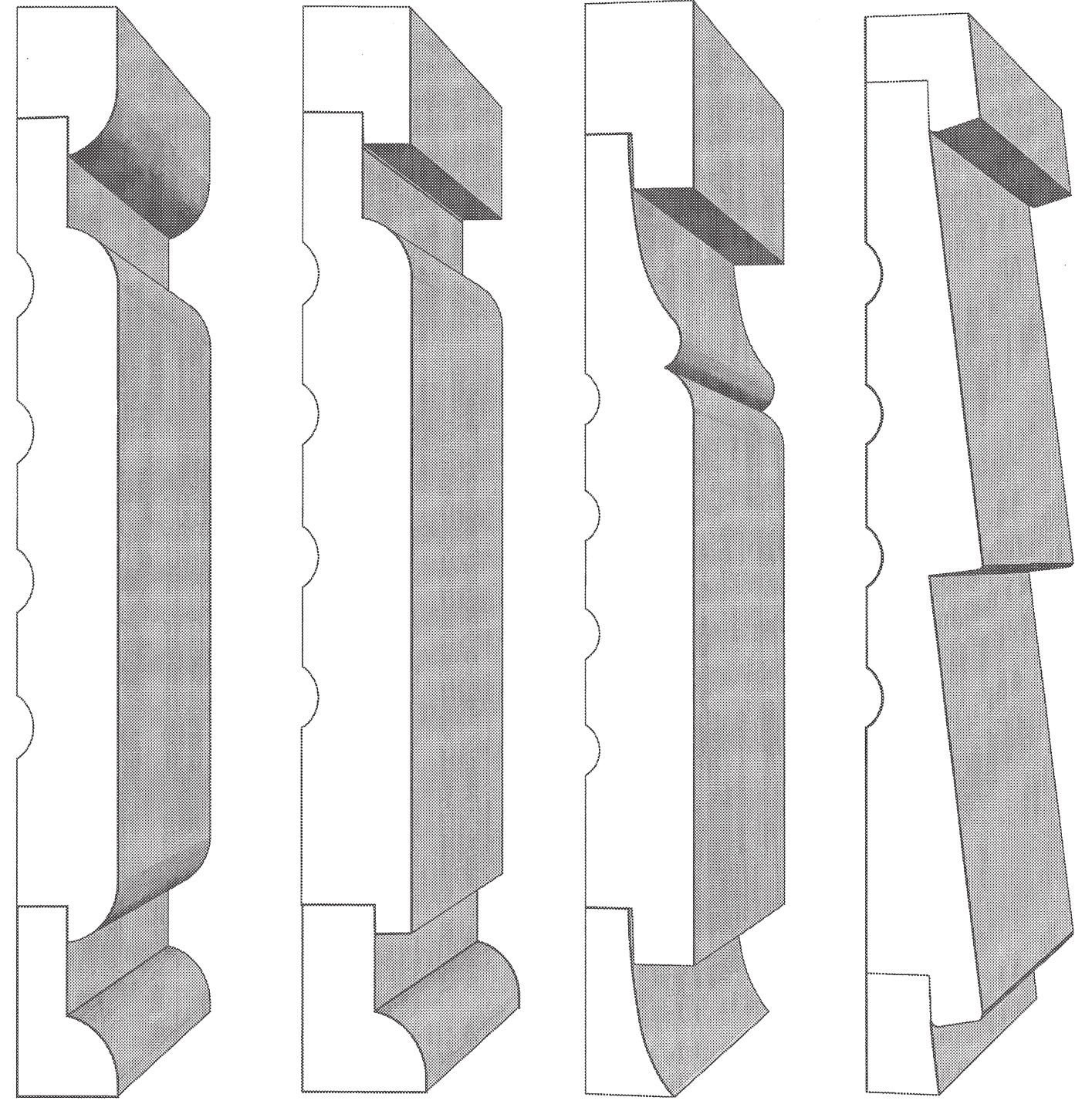

SL-001
3/4" X *

SL-002
3/4" X *

SL-003
3/4" X *

S-004
3/4" X *

* See page 0 for size options.

* See page 0 for size options.



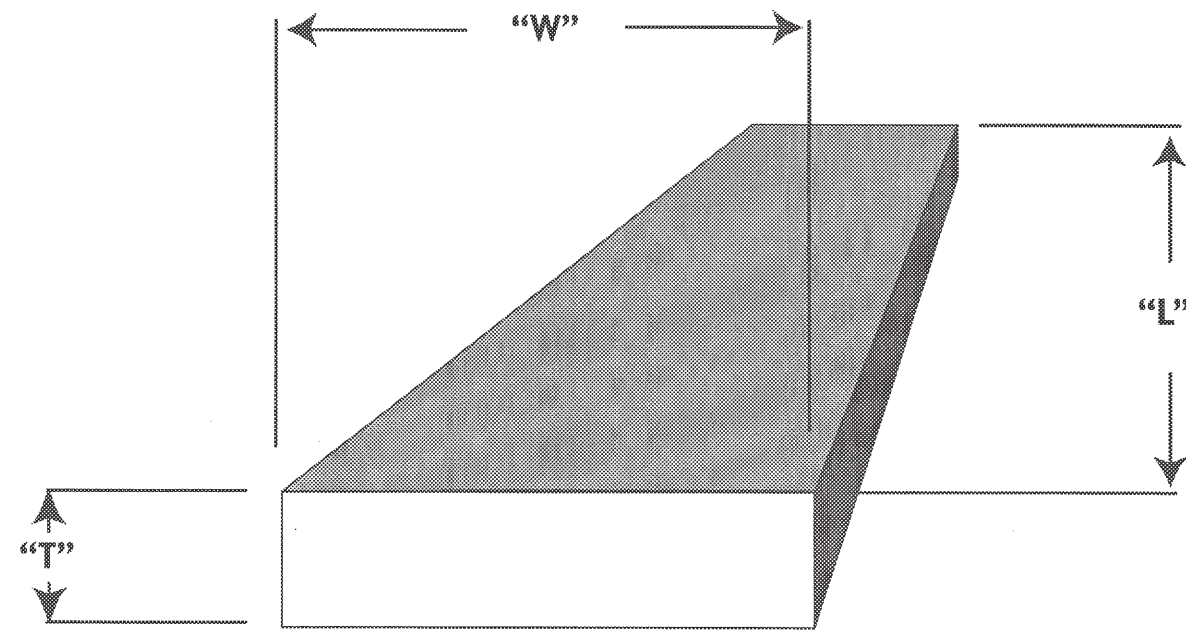

Available in most wood species.
Thickness and Width to order.
Lengths are typically random.

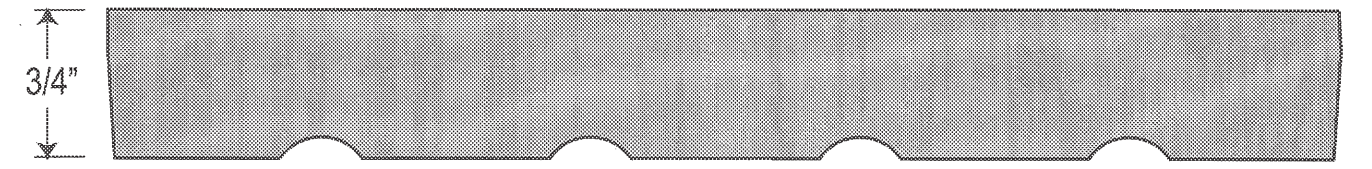

TYPICAL INTERIOR DOOR JAMB

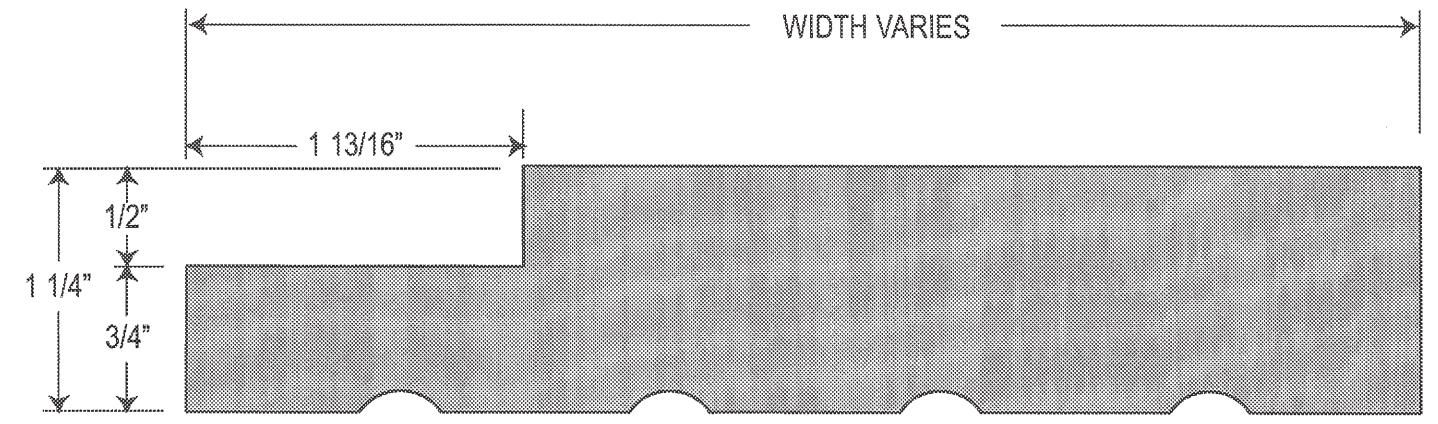

TYPICAL INTERIOR RABBETED JAMB

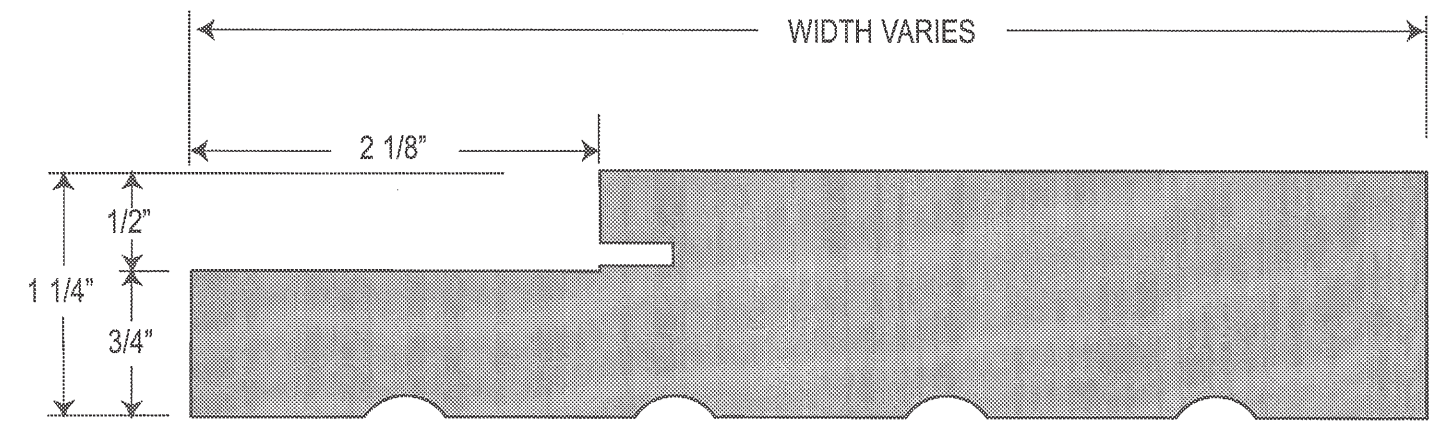

TYPICAL EXTERIOR DOOR JAMBS



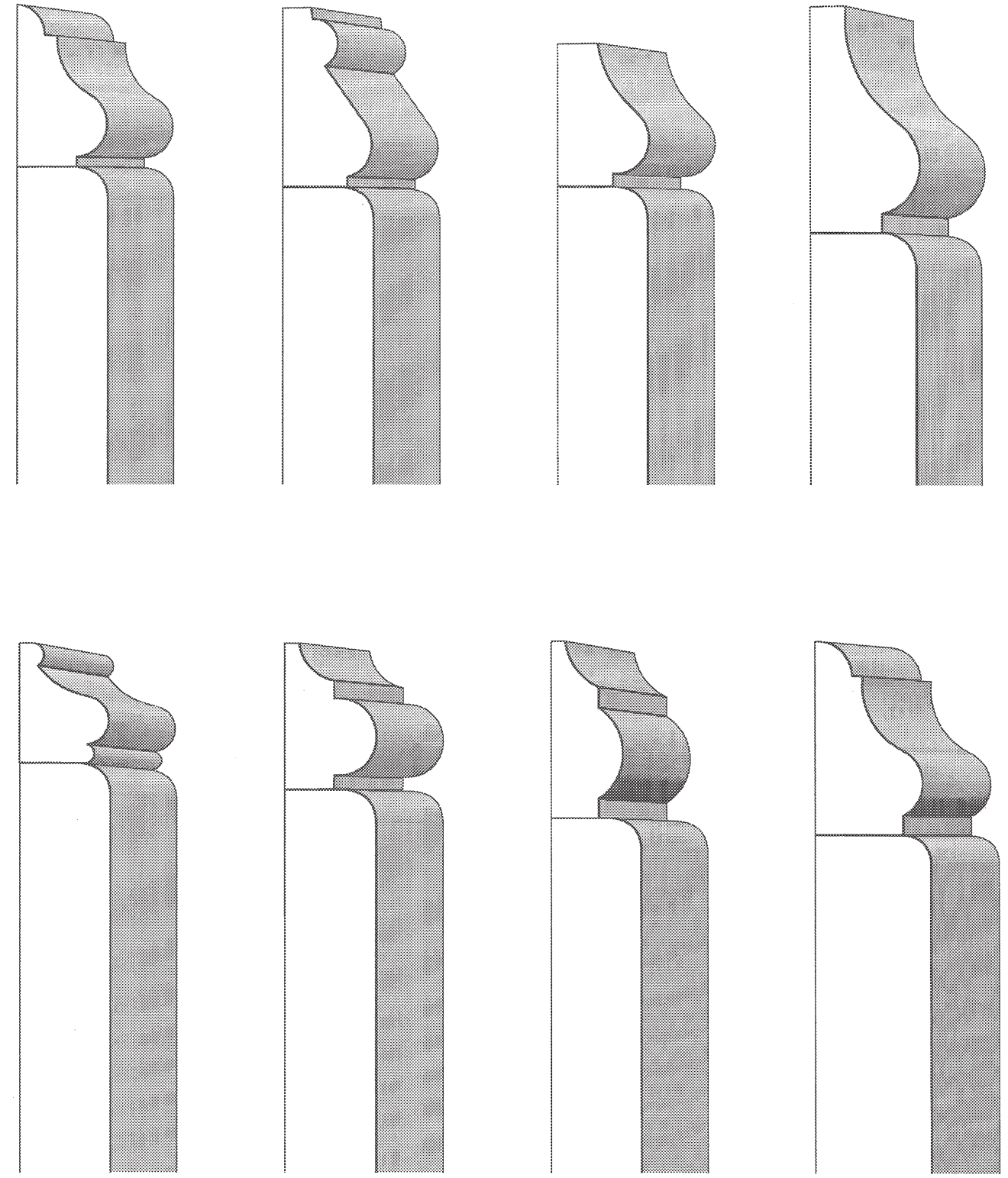
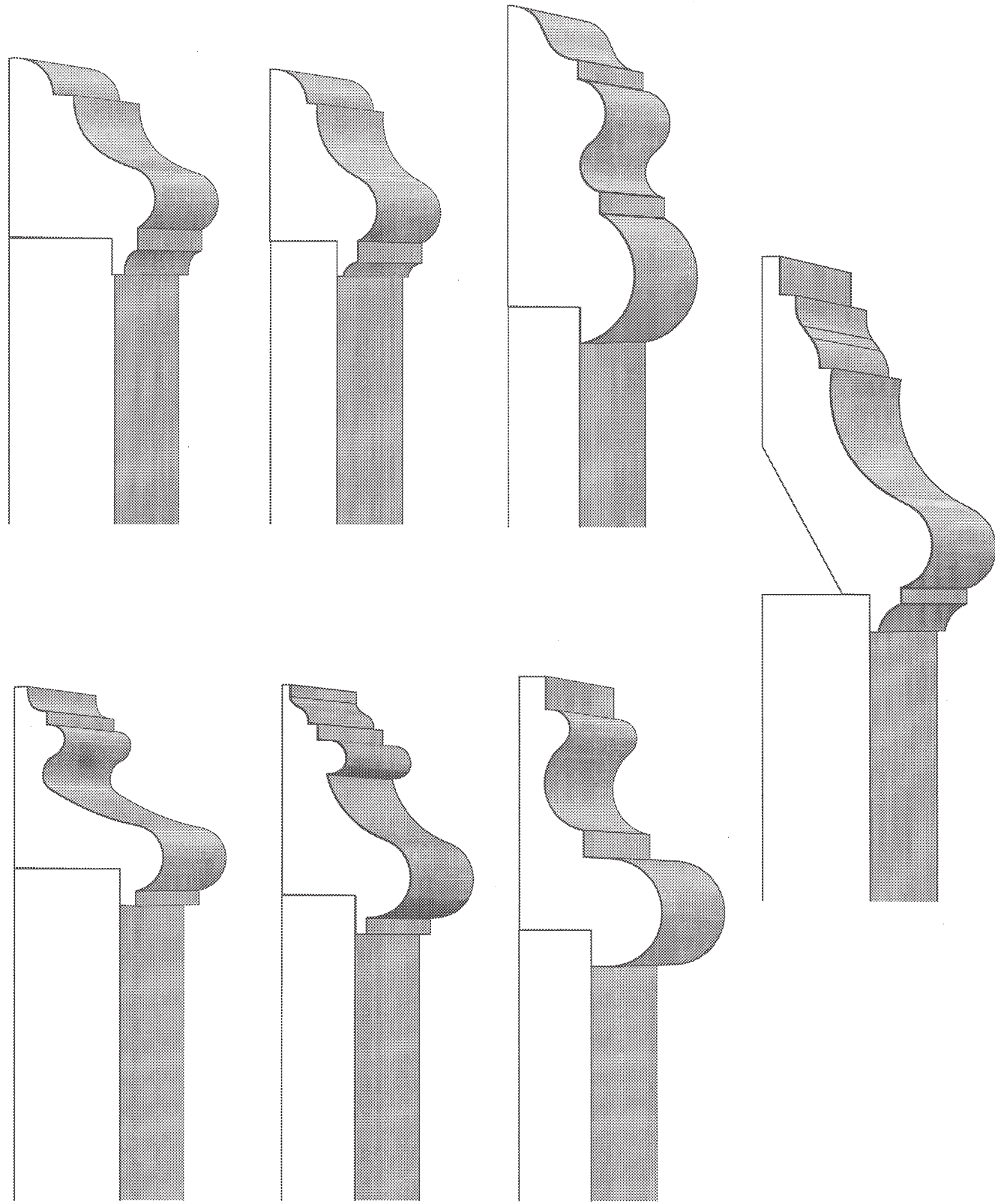

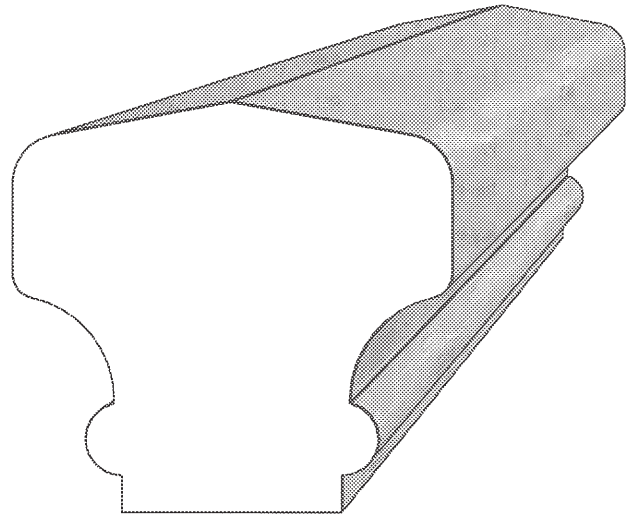

620
2 1/8" x 2 1/4"

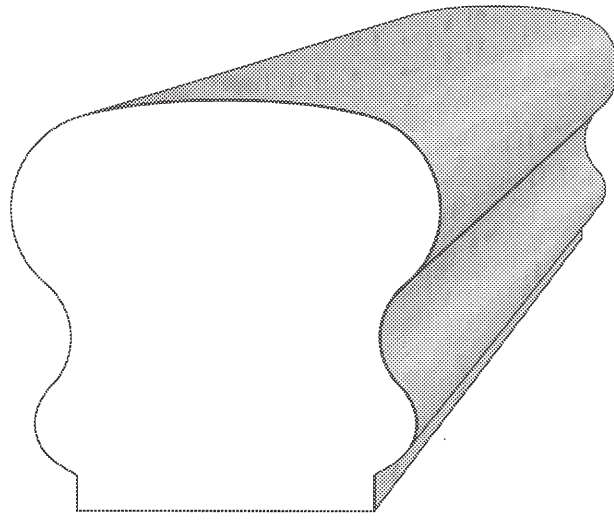

630
2 1/8" x 2 1/4"

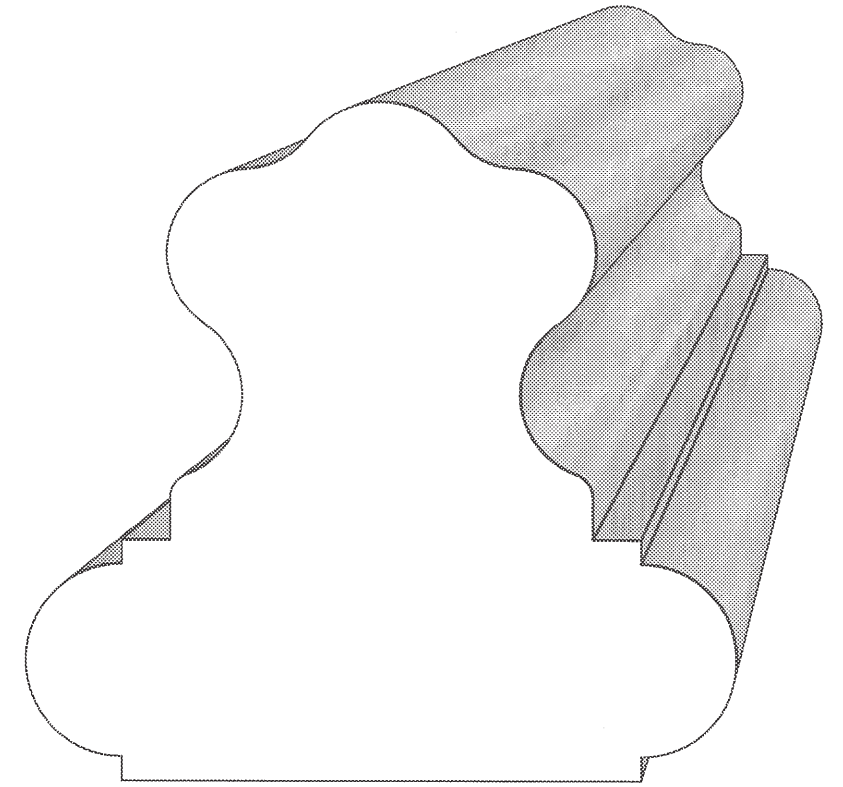

660
3 1/2" x 3 3/4"

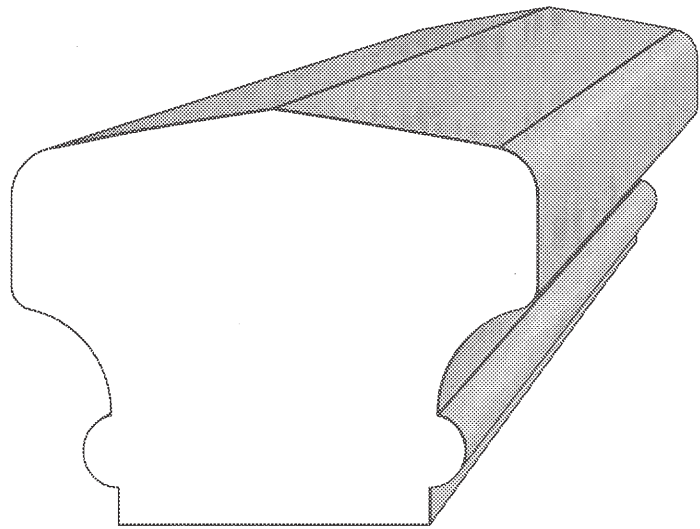

640
2 1/8" x 2 3/4"

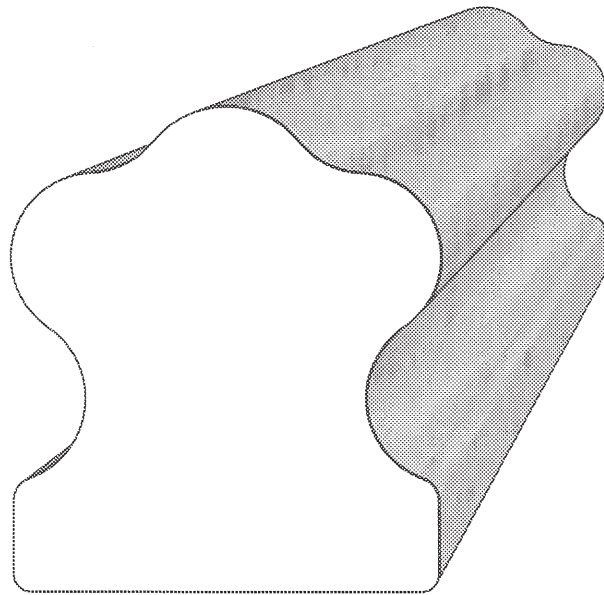

650
2 1/2" x 2 1/4"

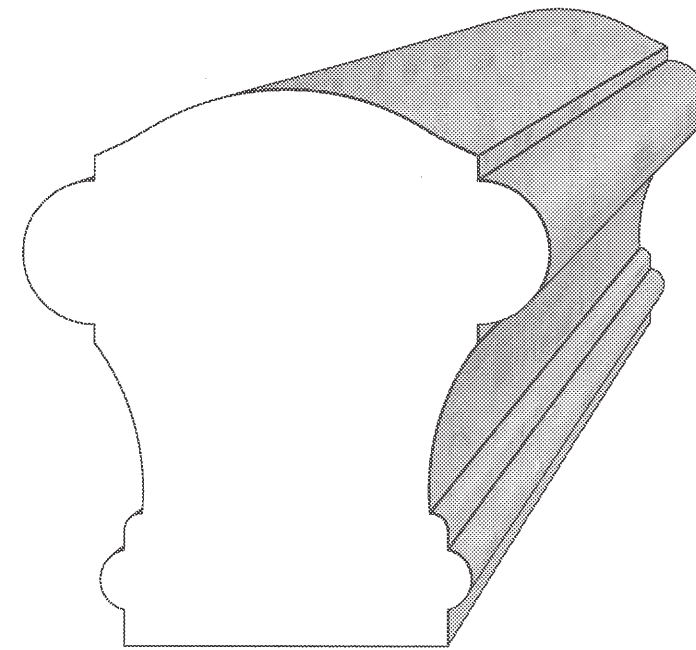

670
2 7/8" x 2 3/4"



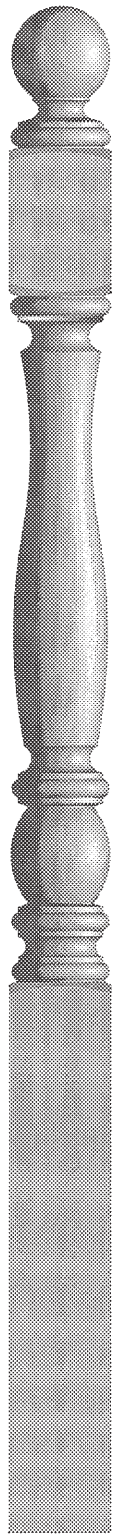

401

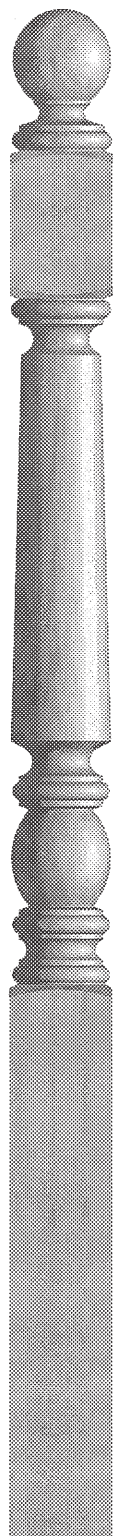

402

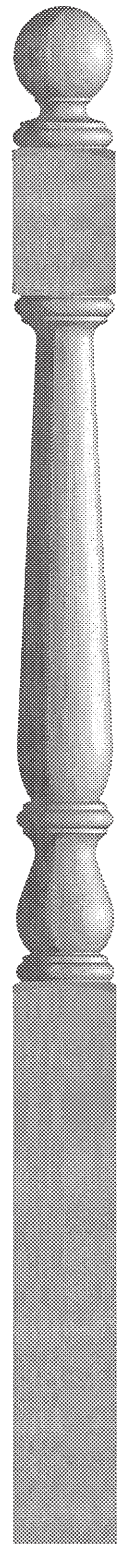

403

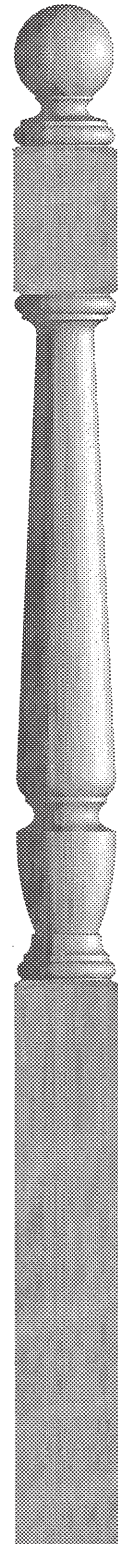

404

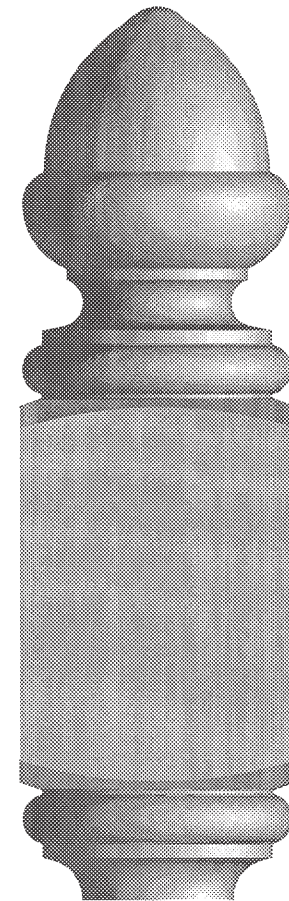

Acorn Top

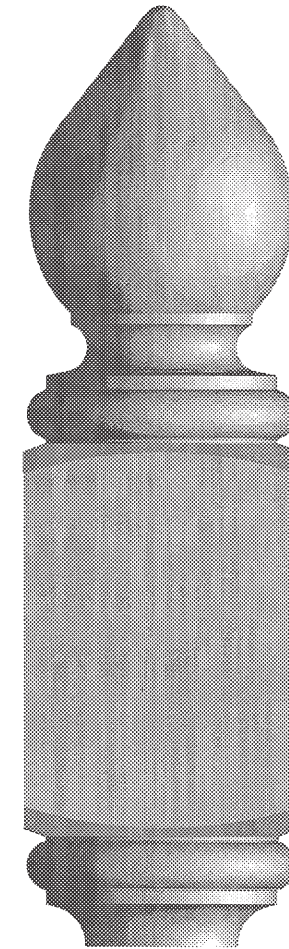

Teardrop Top

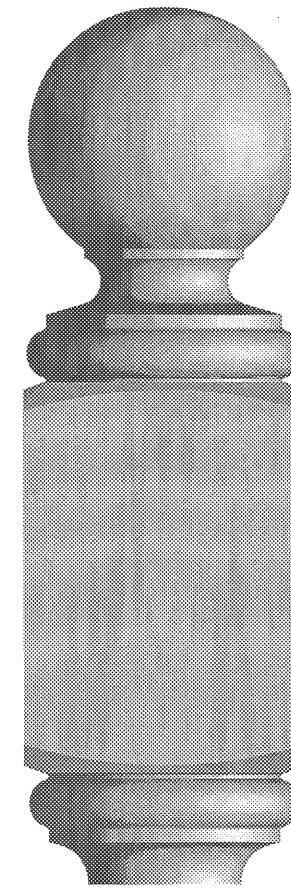

Ball Top

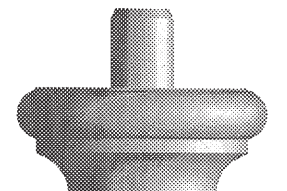

Dowel Top



BALUSTERS

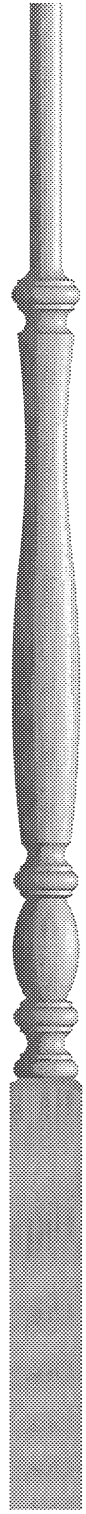

501
1 3/4"x *

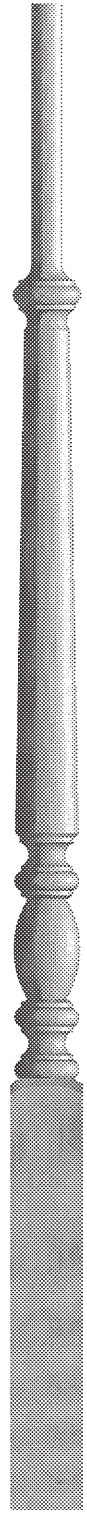

502
1 3/4"x *

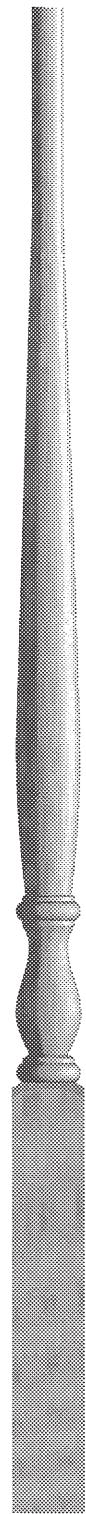

503
1 3/4"x *

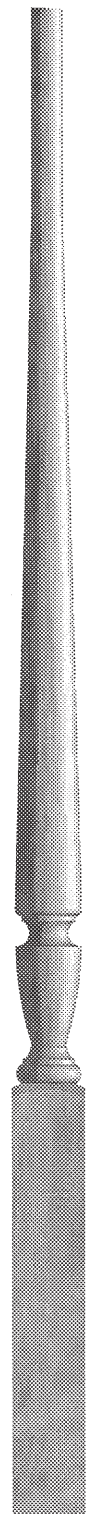

504
1 3/4"x *

* See page 0 for size options.

